

# Singer 81-75

Form 20684  
(853)  
Printed in U.S.A.

# LIST OF PARTS

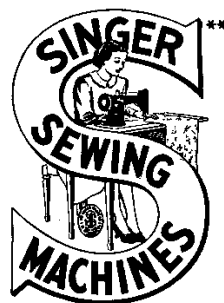

## SINGER\*\*

### MACHINE No. 81-75

---

THE SINGER MANUFACTURING COMPANY

\*\*A Trade Mark of THE SINGER MANUFACTURING COMPANY

From the library of: Diamond Needle Corp

## INSTRUCTIONS FOR OILING

---

To ensure easy running and prevent unnecessary wear of the parts which are in movable contact, the machine requires oiling and when in continuous use, "TYPE B" or "TYPE D" OIL, sold by Singer Sewing Machine Company, should be applied at least twice each day to all oil holes marked "OIL". Before starting the machine, fill the oil reservoir.

"TYPE D" OIL should be used when an oil is desired which will produce a minimum of stain on fabrics, even after a long period of storage.

**CAUTION:** A machine new from the factory, or one that has not been used for some time, SHOULD NOT BE OPERATED UNTIL ABOUT THREE HOURS AFTER FILLING THE RESERVOIRS. Failure to heed this caution may result in serious damage to the mechanism of the machine.

Copyright, U. S. A., 1939 and 1953  
by The Singer Manufacturing Company  
All Rights Reserved for all Countries

## I N D E X

	Page
Accessories .....	13
Bench Stands .....	13
Foot Lifter Parts .....	14
Knee Lifter Parts .....	14
Machine Bases .....	15
Machine Base Oil Drain Jars .....	15
Machine No. 81-75 .....	7
Numerical List of Parts .....	17
Thread Unwinder .....	16

From the library of: Diamond Needle Corp

## INSTRUCTIONS FOR ORDERING

In ordering from this list, use **ONLY** the part NUMBER in the **FIRST** column.

The number stamped on a Sewing Machine Part is in every case the number of the single part only.

Every combination of parts sent out as such has its specific number, which, although not stamped on the parts, must be used when ordering the combination.

Each number always indicates the **SAME PART** in whatever list it appears, or for whatever machine.

The letters after some of the numbers indicate the style of finish only, as follows:

- A—Hardened, Polished, Nickel Plated and Buffed
- A.A—Buffed and Chromium Plated
- A.B—Hardened, Polished, Buffed and Chromium Plated
- A.C—Brown Baking Enamel Finish
- A.D—Gray Baking Enamel Finish
- A.E—Hardened, Bright Rumbled and Nickel Plated
- A.F—Hardened, Bright Rumbled, Nickel Plated, Bright Rumbled and Chromium Plated
- A.G—Alumilite, Plain
- A.H—Alumilite, Dyed
- A.J—Polished, Nickel Plated and Chromium Plated
- A.K—Hardened, Polished, Nickel Plated and Chromium Plated
- A.L—Heat Treated for Toughness
  - B—Polished, Nickel Plated and Buffed
  - C—Hardened Only
- C.R—Hardened and Merlized
  - D—Polished Only
  - E—Soft, Not Polished
  - F—Hardened and Polished
- F.J—Hardened, Polished and Nickel Plated
  - G—Bright Rumbled and Nickel Plated
- H—Blued
- J—Nickel Plated Only
- K—Hardened and Nickel Plated
- L—Brass Plated
- M—Oxidized
- N—Japanned, Dull
- P—Japanned, Bright
- P.P—Wrinkle Finish
- R—Merlized
- S—Cadmium Plated
- T—Copper Plated
- T.A—Hardened, Polished, Copper and Nickel Plated and Buffed
- T.B—Copper and Nickel Plated and Polished
- T.J—Copper and Nickel Plated Only
- T.K—Hardened, Copper and Nickel Plated
- T.L—Copper and Brass Plated
- T.M—Copper Plated and Oxidized

## INSTRUCTIONS FOR ORDERING—Continued

- U—Zinc Plated
- V—Silver Plated
- W—Polished and Nickel Plated
- X—Black Oxide, for Iron and Steel
- X.C—Hardened and Black Oxide, for Iron or Steel
- Y—Black Nickel Plated Only
- Z—Chromium Plated
- Z.A—Hardened, Polished, Nickel Plated, Buffed and Chromium Plated
- Z.B—Polished, Nickel Plated, Buffed and Chromium Plated
- Z.C—Hardened and Chromium Plated
- Z.D—Polished and Chromium Plated
- Z.G—Bright Rumbled, Nickel Plated, Bright Rumbled and Chromium Plated
- Z.J—Nickel and Chromium Plated
- Z.T—Copper and Chromium Plated

These letters **MUST BE USED** when they appear in the list; and **AFTER** the number as in the list.

In this series:

1 to 1500, 50001 to 51500 and 140001 to 142000 are Screw Numbers

1501 to 1800 and 51501 to 51800 are Nut Numbers

1801 to 2000 and 51801 to 52000 are Roller Numbers

2001 to 50000 and 52001 to 140000 and 142001 to 190000 are Sewing Machine Parts, 190001 and upward are numbers of Electrical Parts.

The figures in the second column refer only to the plates, illustrating the parts, and are **NOT TO BE USED** in ordering.

Parts marked with an asterisk (\*) are furnished only when repairs are made at factory.

**SINGER** Needles should be used  
in **SINGER** Machines  
These Needles and their Containers  
are marked with the  
Company's Trade Mark "**SIMANCO.\*\***" 1

Needles in Containers marked  
"**FOR SINGER MACHINES**"  
are **NOT SINGER** made needles. 2

**LIST OF PARTS COMPLETE  
FOR**

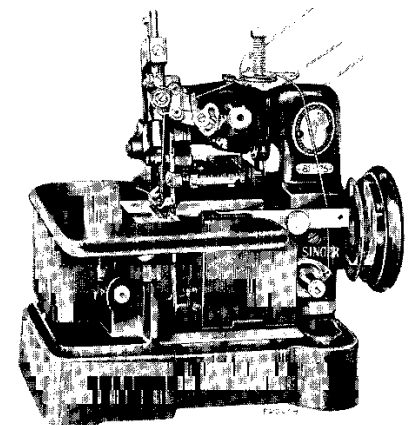

**MACHINE No. 81-75**

FOR TRIMMING AND OVEREDGING HEAVY FABRICS UP TO 5/16" THICK, CLOSING POCKETS AND STITCHING OVER SEAMS IN HEAVY TROUSERS. ONE NEEDLE, TWO LOOPERS. THREE THREAD STITCH. TRIMMER. BIGHT ADJUSTABLE FROM 5/32" TO 7/32". SPEED 4200 R.P.M., DEPENDING ON MATERIALS USED AND OPERATIONS PERFORMED.

No.	Plate	Name
*132724	.....	Arm with 132580, 132739 and two each 462AL, 624AL and 132589.....
4389	23074	Arm Dowel Pin (2).....
68350	23074	Arm Oil Cup.....
949E	23074	Arm Screw (2).....
132654	23075	Chip Guard.....
132962	23075	Cloth Plate with Hinge Bracket.....
132601	23075	Cloth Plate Extension (lower).....
233E	23075	Cloth Plate Extension (lower) Screw (3).....
42108	23075	Cloth Plate Extension (upper).....
233E	23075	Cloth Plate Extension (upper) Screw (2).....
132526	23075	Cloth Plate Hinge Stud.....
50150AL	23075	Cloth Plate Hinge Stud Set Screw.....
42005	23075	Cloth Plate Lock Spring.....
236C	23075	Cloth Plate Lock Spring Screw (2).....
132963	23075	Cloth Plate complete, Nos. 42005, 42108, 132601, 136962, two 236C and five 233E.....
42205	23404	Feed Bar with 1253AL.....
132642	.....	Feed Bar 42205 with 132539.....
132528	23404	Feed Bar Hinge Pin.....
1253AL	23404	Feed Bar Hinge Pin Set Screw.....
132937	23405	Feed Connecting Rod with 171AL, 1695J, 68497, 134260 and two 1057AL.....

SINGER Needles should be used in SINGER Machines. These Needles and their Containers are marked with the Company's Trade Mark "SIMANCO.\*\*" 1

Needles in Containers marked "FOR SINGER MACHINES" are NOT SINGER made needles. 2

From the library of: Diamond Needle Corp

## PARTS FOR MACHINE No. 81-75

No.	Plate	Name
132938		Feed Connecting Rod 132937 with 132644
1057AL	23405	Feed Connecting Rod Cap Screw (2)
51292C	23405	Feed Connecting Rod Hinge Screw
171AL	23405	Feed Connecting Rod Hinge Screw Clamping Screw
1695J	23405	Feed Connecting Rod Hinge Screw Clamping Screw Nut
1520J	23405	Feed Connecting Rod Hinge Screw Nut
68497		Feed Connecting Rod Oil Pad
134260		Feed Connecting Rod Oil Pad Retainer
132964	23406	Feed Dog, 26 teeth (16 teeth to the inch) for 132824
190J	23406	Feed Dog Screw
1036AL	23405	Feed Eccentric Body Set Screw (2)
19047	23405	Feed Eccentric Clamping Washer
201J	23405	Feed Eccentric Clamping Washer Screw
132533	23405	Feed Eccentric Oil Tube
132644	23405	Feed Eccentric complete, Nos. 201J, 19047, 51145C, 132533 and two 1036AL
132651	23074	Feed Eccentric Cover
50253J	23074	Feed Eccentric Cover Screw (2)
132712	23405	Feed Eccentric Lint Cover (spring)
132785	23405	Feed Eccentric Lubricator with 132537
132537	23405	Feed Eccentric Lubricator Oil Wick (braided cotton)
132965	23405	Feed Lifting Eccentric with two 462AL
132539	23405	Feed Lifting Eccentric Connection
462AL	23405	Feed Lifting Eccentric Set Screw (2)
51145C	23405	Feed Regulating Screw
132625	23404	Feed Rock Shaft
132626		Feed Rock Shaft complete, Nos. 42021 and 132625
42021	23404	Feed Rock Shaft Crank with 157E
157E	23404	Feed Rock Shaft Crank Clamping Screw
132542	23404	Feed Rock Shaft Hinge Pin with 132544
132543	23404	Feed Rock Shaft Hinge Pin Bushing (2)
132816	23404	Feed Rock Shaft Hinge Pin Bushing Oil Wick (2)
1036AL	23404	Feed Rock Shaft Hinge Pin Bushing Set Screw (2)
132544	23404	Feed Rock Shaft Hinge Pin Oil Wick (braided cotton)
*132545		Frame
132546	23075	Frame Bottom Cover with 132594
132547	23075	Frame Bottom Cover Gasket
190E	23075	Frame Bottom Cover Screw (7)
132548	23074	Frame Oil Cup
132788	23405	Frame Rotary Shaft with 132558 and 132559
132789		Frame Rotary Shaft 132788 with 132790, 132802, 132806 and 132932
132790	23405	Frame Rotary Shaft Ball Sleeve (two pieces)
132932	23405	Frame Rotary Shaft Ball Sleeve Guide
132810	23405	Frame Rotary Shaft Bushing (front) with 132835, 132864 and two 132715
132864	23405	Frame Rotary Shaft Bushing (front) Oil Pad (braided cotton)
132715	23405	Frame Rotary Shaft Bushing (front) Oil Pad Retainer (2)
132817	23405	Frame Rotary Shaft Bushing (front) Oil Wick
51332C	23405	Frame Rotary Shaft Bushing (front) Set Screw
132954	23405	Frame Rotary Shaft Crank with 1036AL and 1375AL
1375AL	23405	Frame Rotary Shaft Crank Position Screw
1036AL	23405	Frame Rotary Shaft Crank Set Screw
132835	23405	Frame Rotary Shaft Crank Oil Sling Cover
132865	23405	Frame Rotary Shaft Flanged Bushing (back)
132866		Frame Rotary Shaft Flanged Bushing (back) 132865 with 132692, 132867, 132868 and two 132603
132867	23405	Frame Rotary Shaft Flanged Bushing (back) Oil Pad (large) (braided cotton)
132868	23405	Frame Rotary Shaft Flanged Bushing (back) Oil Pad (small) (braided cotton)
132603	23405	Frame Rotary Shaft Flanged Bushing (back) Oil Pad Retainer (2)

## PARTS FOR MACHINE No. 81-75

No.	Plate	Name
132817	23405	Frame Rotary Shaft Flanged Bushing (back) Oil Wick
51332C	23405	Frame Rotary Shaft Flanged Bushing (back) Set Screw
132558	23405	Frame Rotary Shaft Oil Pad (wick)
132559	23405	Frame Rotary Shaft Oil Pad Retainer
132692	23405	Frame Rotary Shaft Oil Sling Cover
132560	23075	Frame Side Cover (left) with 132701
132701	23075	Frame Side Cover (left) Handle
330W	23075	Frame Side Cover (left) Screw (2)
42028	23075	Frame Side Cover (right) hinged
42101	23074	Frame Side Cover (right) Lock Spring
330W	23075	Frame Side Cover (right) Screw (2)
132946	23075	Frame Top Cover with 132950
132947		Frame Top Cover 132946 with 132783, 132784, 132948, 132952 and two 197J
132650	23074	Frame Top Cover Extension
42102	23074	Frame Top Cover Extension Holder
132600	23074	Frame Top Cover Extension Holder 42102 with 42101, 132650, 132651 and two each 176J and 50253J
283W	23074	Frame Top Cover Extension Holder Thumb Screw
19044	23074	Frame Top Cover Extension Holder Thumb Screw Washer
176J	23074	Frame Top Cover Extension Screw (2)
132948	23075	Frame Top Cover Oil Reservoir Cover
197J	23075	Frame Top Cover Oil Reservoir Cover Screw (2)
132783	23075	Frame Top Cover Oil Tube (long)
132952	23075	Frame Top Cover Oil Tube Wick
132950	23075	Frame Top Cover Oil Tube (short)
132784	23075	Frame Top Cover Oil Tube Wick
583F	23075	Frame Top Cover Screw (large)
742F	23075	Frame Top Cover Screw (small) (2)
42305	23407	Knife (movable) (2)
42306	23407	NOTE: Two No. 42305 are sent with this Machine.
132926	23407	Knife (movable) Gib
132927	23407	Knife (movable) Holder
132928	23407	Knife (movable) Holder 132926 with 133F, 42040, 42306, 132928 and two 220E
220E	23407	Knife (movable) Holder Cap
42038	23407	Knife (movable) Holder Cap Screw (2)
42039	23407	Knife (movable) Holder Cap Guide with 336F
621E	23407	Knife (movable) Holder Cap Guide Plate
336F	23407	Knife (movable) Holder Cap Guide Plate Screw (2)
133F	23407	Knife (movable) Holder Cap Guide Set Screw
42040	23407	Knife (movable) Holder Screw
42041	23407	Knife (movable) Holder Screw Extension Pin
132821	23407	Knife (movable) Holder Spring
132966	23405	Knife (movable) Lever with 175E
132967	23405	Knife (movable) Lever Connection with two 1057AL
1057AL	23405	Knife (movable) Lever Connection 132966 with 132965
132565	23405	Knife (movable) Lever Connection Cap Screw (2)
175E	23407	Knife (movable) Lever Connection Hinge Stud
42045	23407	Knife (movable) Lever Connection Hinge Stud Set Screw
1229C	23407	Knife (movable) Lever Hinge Stud
42309	23407	Knife (movable) Lever Hinge Stud Set Screw
42310	23407	NOTE: Two No. 42309 are sent with this machine.
1534D	23407	Knife (stationary) Clamping Stud
132767	23407	Knife (stationary) Clamping Stud Thumb Nut
1376C	23407	Knife (stationary) Holder
1101C	23407	Knife (stationary) Holder Regulating Thumb Screw
440AL	23407	Knife (stationary) Holder Screw
1547J	23407	Knife (stationary) Holder Stop Screw (2)
42049	23407	Knife (stationary) Holder Stop Screw Nut (2)
132811	23408	Knife (stationary) Stud (2)
50117AL	23408	Looper (left hand)
	23408	Looper (left hand) Clamping Screw

From the library of: Diamond Needle Corp

## PARTS FOR MACHINE No. 81-75

No.	Plate	Name
132795	23408	Looper (left hand) Lever with 50117AL
132796	23408	Looper (left hand) Lever Connecting Link (2)
132797	23408	Looper (left hand) Lever Connecting Link Hinge Pin (2)
51459E	23408	Looper (left hand) Lever Connecting Link Screw (2)
1735J	23408	Looper (left hand) Lever Connecting Link Screw Nut (2)
132798	23408	Looper (left hand) Lever Hinge Stud with 132552
132552	23408	Looper (left hand) Lever Hinge Stud Oil Pad (braided cotton)
132816	23408	Looper (left hand) Lever Hinge Stud Oil Wick
1036AL	23408	Looper (left hand) Lever Hinge Stud Set Screw
132968	23408	Looper (right hand)
132799	23408	Looper (right hand) and Spreader Lever with 233E, 241E and 140123AL
132800	.....	Looper (right hand) and Spreader Lever 132799 with 132699
132801	.....	Looper (right hand) and Spreader Lever 132800 with 42242, 132795, 132798 and two each 1735J, 51459E, 132796 and 132797
132776	23405	Looper (right hand) and Spreader Lever Ball Stud
140123AL	23408	Looper (right hand) and Spreader Lever Ball Stud Set Screw
132956	23405	Looper (right hand) and Spreader Lever Connection with two 1057AL
132958	.....	Looper (right hand) and Spreader Lever Connection 132956 with 1664E, 51736C, 132776, 132954, 132960, 132961, 143098 and sixteen 132959
1057AL	23405	Looper (right hand) and Spreader Lever Connection Cap Screw (2)
132959	23405	Looper (right hand) and Spreader Lever Connection Roller Bearing (16)
132960	23405	Looper (right hand) and Spreader Lever Connection Roller Bearing Housing with 223C
223C	23405	Looper (right hand) and Spreader Lever Connection Roller Bearing Housing Clamping Screw
132961	23405	Looper (right hand) and Spreader Lever Connection Roller Bearing Housing Hinge Pin
51736C	23405	Looper (right hand) and Spreader Lever Connection Roller Bearing Retaining Nut
1664E	23405	Looper (right hand) and Spreader Lever Connection Roller Bearing Retaining Nut Lock Nut
143098	.....	Looper (right hand) and Spreader Lever Connection Roller Bearing Retaining Washer
132699	23408	Looper (right hand) and Spreader Lever Hinge Pin with 125056
132543	23408	Looper (right hand) and Spreader Lever Hinge Pin Bushing
132816	23408	Looper (right hand) and Spreader Lever Hinge Pin Bushing Oil Wick
1036AL	23408	Looper (right hand) and Spreader Lever Hinge Pin Bushing Set Screw
125056	23408	Looper (right hand) and Spreader Lever Hinge Pin Oil Pad (braided cotton)
1036AL	23408	Looper (right hand) and Spreader Lever Hinge Pin Set Screw
241E	23408	Looper (right hand) and Spreader Lever Oil Plug Screw
197J	23408	Looper (right hand) Screw
132925	23405	Machine Driving Pulley, "V" belt groove (outside diam. of belt groove 2.9 in.) with 448AL and 1299AL
1299AL	23405	Machine Driving Pulley Position Screw
448AL	23405	Machine Driving Pulley Set Screw
38534	23408	Needle Bar (hollow)
132739	23408	Needle Bar Bushing (lower)
132580	23408	Needle Bar Bushing (upper)
132581	23408	Needle Bar Bushing (upper) Oil Pad (braided cotton) (2)

## PARTS FOR MACHINE No. 81-75

No.	Plate	Name
132621	23408	Needle Bar Bushing (upper) Oil Pad Cover
217J	23408	Needle Bar Bushing (upper) Oil Pad Cover Screw
462AL	23408	Needle Bar Bushing Set Screw (2)
132740	23408	Needle Bar Connecting Bracket with 223F and 1057AL
1057AL	23408	Needle Bar Connecting Bracket Clamping Screw
132582	23408	Needle Bar Connecting Link
132583	23408	Needle Bar Connecting Link Hinge Pin with 132584 (2)
132584	23408	Needle Bar Connecting Link Hinge Pin Oil Pad (wick) (2)
223F	23408	Needle Bar Connecting Link Hinge Pin Set Screw for 132740
620AL	23408	Needle Bar Connecting Link Hinge Pin Set Screw for 132597
132806	23405	Needle Bar Connecting Rod with four 896AL
896AL	23405	Needle Bar Connecting Rod Cap (lower) Screw (2)
896AL	23405	Needle Bar Connecting Rod Cap (upper) Screw (2)
132879	23408	Needle Bar Crank (back) with 132590 and two 1259AL
132802	23405	Needle Bar Crank (back) Ball Stud
1259AL	23408	Needle Bar Crank (back) Ball Stud Set Screw (2)
132589	23408	Needle Bar Crank (back) Bushing (2)
624AL	23408	Needle Bar Crank (back) Bushing Set Screw (2)
132590	23408	Needle Bar Crank (back) Oil Pad (wick)
132880	23408	Needle Bar Crank (front) with 620AL, 50200C and 140123AL
132881	.....	Needle Bar Crank (front) 132880 with 132582, 132740 and two 132583
140123AL	23408	Needle Bar Crank (front) Position Screw
50200C	23408	Needle Bar Crank (front) Set Screw
42115	23408	Needle Bar Thread Retainer Bracket
42483	23408	Needle Bar Thread Retainer Disc (2)
93AL	23408	Needle Bar Thread Retainer Screw
10107	23408	Needle Bar Thread Retainer Spring
132723	.....	Needle Bar Thread Retainer complete, Nos. 93AL, 10107, 42115 and two 42483
1737C	23408	Needle Clamping Nut
42066	23407	Needle Guard
171F	23407	Needle Guard Screw
132969	23406	Presser Foot Chaining-off Finger
233J	23406	Presser Foot Chaining-off Finger Screw
132970	23406	Presser Foot Chaining-off Plate
132610	23406	Presser Foot Chaining-off Plate Collar with 240C
132611	23406	Presser Foot Chaining-off Plate Collar Guide Pin
735AL	23406	Presser Foot Chaining-off Plate Collar Guide Pin Set Screw
240C	23406	Presser Foot Chaining-off Plate Collar Set Screw
14058	23406	Presser Foot Chaining-off Plate Spring
42461	23406	Presser Foot Hinge Pin
132971	23406	Presser Foot Plate
132972	23406	Presser Foot Shank with 735AL
132973	23406	Presser Foot (hinged) complete, for closing pockets and stitching over heavy seams in trousers, Nos. 233J, 14058, 42461, 132610, 132611, 132969, 132970, 132971 and 132972
1324C	23406	Presser Foot Screw
39541	23406	Presser Foot Screw Washer
42227	23404	Presser Lever
42377	.....	Presser Lever 42227 with 42045
42045	23404	Presser Lever Hinge Stud
1120AL	23404	Presser Lever Hinge Stud Set Screw
42070	22404	Presser Lever Lifter
85D	23404	Presser Lever Lifter Hinge Screw
1377C	23404	Presser Lever Screw Stud (eccentric)
1547J	23404	Presser Lever Screw Stud Nut
42071	23404	Presser Lever Spring
1378D	23404	Pressure Regulating Thumb Screw
132974	23408	Spreader (For Two-Thread Stitch)

## PARTS FOR MACHINE No. 81-75

No.	Plate	Name
197J	23408	Spreader Screw (For Two-Thread Stitch)
2102	23074	Tension (looper, left hand) Disc (2)
51570C	23074	Tension (looper, left hand) Regulating Thumb Nut
50326C	23074	Tension (looper, left hand) Screw Stud
59539	.....	Tension (looper, left hand) Screw Stud 50326C with 51570C
59534	23074	Tension (looper, left hand) Spring
59537	23074	Tension (looper, left hand) Spring Bushing (large)
59538	23074	Tension (looper, left hand) Spring Bushing (small)
132599	23074	Tension (looper, left hand) Thread Guide
2102	23074	Tension (looper, right hand) Disc (2)
51570C	23074	Tension (looper, right hand) Regulating Thumb Nut
50148C	23074	Tension (looper, right hand) Screw Stud
132871	.....	Tension (looper, right hand) Screw Stud 50148C with 51570C
59535	23074	Tension (looper, right hand) Spring
59537	23074	Tension (looper, right hand) Spring Bushing (large)
59538	23074	Tension (looper, right hand) Spring Bushing (small)
131696	23074	Tension (looper, right hand) Thread Guide
2102	23074	Tension (needle thread) Disc (2)
51570C	23074	Tension (needle thread) Regulating Thumb Nut
50261C	23074	Tension (needle thread) Screw Stud
132360	.....	Tension (needle thread) Screw Stud 50261C with 51570C
131740	23074	Tension (needle thread) Spring
59537	23074	Tension (needle thread) Spring Bushing (large)
59538	23074	Tension (needle thread) Spring Bushing (small)
42082	23074	Tension (needle thread) Thread Guide
42242	23408	Thread (looper, left hand) Eyelet
233E	23408	Thread (looper, left hand) Eyelet Screw
42122	23405	Thread (looper, left hand) Nipper Spring (lower)
42123	23405	Thread (looper, left hand) Nipper Spring (upper)
176J	23405	Thread (looper, left hand) Nipper Spring Screw
132591	23405	Thread (looper, left hand) Pull-off
42244	23075	Thread (looper, left hand) Pull-off Eyelet
207J	23075	Thread (looper, left hand) Pull-off Eyelet Screw
42084	23404	Thread (looper, left hand) Tube
462AL	23404	Thread (looper, left hand) Tube Set Screw
132872	23405	Thread (looper, right hand) Controller
42126	23405	Thread (looper, right hand) Pull-off
132664	23408	Thread (looper, right hand) Staple
176J	23408	Thread (looper, right hand) Staple Screw
7071	23408	Thread (looper, right hand) Staple Screw Washer
132812	23408	Thread (looper, right hand) Take-up
185J	23408	Thread (looper, right hand) Take-up Screw
132873	23408	Thread (needle) Eyelet with 52130
52130	23408	Thread (needle) Eyelet Bushing
223J	23408	Thread (needle) Eyelet Screw
132623	23408	Thread (needle) Take-up
197J	23408	Thread (needle) Take-up Screw (2)
132824	23406	Throat Plate, for 132964
742F	23406	Throat Plate Screw (2)

## ACCESSORIES

No.	Plate	Name
137258	23409	Machine Base Screw Stud
137259	23409	Machine Base Screw Stud 137258 with 51756E, for 1-5/8 in. Table and Individual Stands, for use when machine is mounted on top of table
137260	23409	Machine Base Screw Stud
137261	23409	Machine Base Screw Stud 137260 with 51756E, for use when machine is mounted 1-1/2 in. lower than standard
14063	23409	Machine Base Screw Stud Spring, for Screw Stud No. 137258 when machine is mounted on individual Stand
27498	23409	Machine Base Screw Stud Spring, for Screw Stud No. 137260 when machine is mounted 1-1/2 in. lower than standard
9842	23411	Machine Base Screw Stud Spring Washer
132602	23409	Machine Base Screw Stud Washer
51756E	23409	Machine Base Screw Stud Wing Nut for 137259 and 137261
120344	23409	Oiler with 120345
120345	23409	Oiler Spout
120440	23409	Screw Driver
42090	23409	Threading Wire
120341	23409	Tweezers (curved)
42089	23409	Wrench for 1324 and 1737
8908	23409	Wrench for 1520
4822	23409	Wrench for 1547
22003	23409	Wrench

## BENCH STANDS

## BENCH STAND No. 79768

(for Machine Base No. 132592)

## WHEN MACHINE IS MOUNTED ON TOP OF TABLE

79768	.....	Bench Stand with 27998, two each 28291, 46548 and wood screws 1-1/2 in. No. 14 F.H.
28291	23409	Cover Hinge with two each wood screws 1/2 in. No. 5 F.H. and 5/8 in. No. 5 F.H. (2)
27998	23409	Cover Hook and Eye (brass) with wood screw 1/2 in. No. 5 F.H.
46548	23409	Cover Rest (felt) (2)

## BENCH STAND No. 79790

(for Machine Base No. 132656)

## WHEN MACHINE IS MOUNTED 1-1/2 IN. LOWER THAN STANDARD

79790	.....	Bench Stand with 27998, 60820, two each 28291, 46548, 150244 and three each wood screws 1-1/4 in. No. 12 F.H. and 1-1/2 in. No. 14 F.H.
60820	23409	Cover Chain, 9-1/4 in. long with two 56865
56865	23409	Cover Chain Hook (2)
150244	23409	Cover Chain Hook Screw Eye (2)
28291	23409	Cover Hinge with two each wood screws 1/2 in. No. 5 F.H. and 5/8 in. No. 5 F.H. (2)
27998	23409	Cover Hook and Eye (brass) with wood screw 1/2 in. No. 5 F.H.
46548	23409	Cover Rest (felt) (2)



### FOOT LIFTER PARTS

No.	Plate	Name
6439	23410	Chain, 36 in. to 45 in. with 56864 and 56865.....
NOTE: When ordering No. 6439, state length required.		
4879	23410	Chain Connecting Link.....
56864	23410	Chain Hook (large).....
56865	23410	Chain Hook (small).....
42130	23410	Lifting Lever.....
42131	23410	Lifting Lever Bracket.....
1229C	23410	Lifting Lever Bracket Screw (2).....
1301D	23410	Lifting Lever Hinge Screw.....
42132	23410	Lifting Lever Spring.....
1148AL	23410	Lifting Lever Stop Screw (2).....
1547J	23410	Lifting Lever Stop Screw Nut (2).....
4881	23410	Treadle.....
4882	23410	Treadle Shaft.....
4883	23410	Treadle Spring.....
4884	23410	Treadle Stand.....
4885	23410	Treadle complete, Nos. 4879, 4881, 4882, 4883, 4884 and two wood screws 1 in. No. 16.....
42133	23410	Foot Lifter complete, Nos. 1301D, 4885, 6439, 42130, 42131, 42132 and two each 1148AL, 1229C and 1547J..

### KNEE LIFTER PARTS

42130	23037	Lifting Lever.....
42131	23037	Lifting Lever Bracket.....
1229C	23037	Lifting Lever Bracket Screw (2).....
42142	23037	Lifting Lever Connecting Rod.....
1301D	23037	Lifting Lever Hinge Screw.....
42132	23037	Lifting Lever Spring.....
1148F	23037	Lifting Lever Stop Screw (2).....
1547J	23037	Lifting Lever Stop Screw Nut (2).....
2763	23037	Rock Shaft.....
12242	23037	Rock Shaft Hanger with two wood screws 1 in. No. 10 (2) ..
2765	23037	Rock Shaft Knee Arm.....
2766	23037	Rock Shaft Knee Arm Hub with 356C.....
356C	23037	Rock Shaft Knee Arm Hub Set Screw.....
2768	.....	Rock Shaft Knee Arm complete, Nos. 2765, 2766 and 2767.....
2767	23037	Rock Shaft Knee Plate with 356C.....
356C	23037	Rock Shaft Knee Plate Set Screw.....
6337	23037	Rock Shaft Lifting Bracket with two 356C.....
7125	23037	Rock Shaft Lifting Bracket Hook.....
356C	23037	Rock Shaft Lifting Bracket Hook Set Screw.....
356C	23037	Rock Shaft Lifting Bracket Set Screw.....
2770	23037	Rock Shaft Stop Dog with 140219C (2).....
140219C	23037	Rock Shaft Stop Dog Set Screw (2).....
42143	23037	Rock Shaft complete, Nos. 2763, 2768, 6337, 7125 and two each 2770 and 12242.....
42144	23037	Knee Lifter complete, Nos. 1301D, 42130, 42131, 42132, 42142, 42143 and two each 1148F, 1229C, and 1547J..

### MACHINE BASES

MACHINE BASE No. 132592  
(When machine is mounted on top of table)  
FOR USE WITH BENCH STAND No. 79768

No.	Plate	Name
132647	23411	Machine Base.....
132595	23411	Machine Base Cushion (felt, large) (4).....
42088	23411	Machine Base Cushion (felt, small) (4).....
132618	23411	Machine Base Cushion (felt, small).....
935E	23411	Machine Base Cushion (felt, small) Screw (4).....
66707	23411	Machine Base Cushion (felt, small) Screw Washer.....
132596	23411	Machine Base Cushion (leather).....
132593	23411	Machine Base Oil Drain Strainer.....
54477	23411	Machine Base Screw Stud (3).....
51576E	23411	Machine Base Screw Stud Nut (3).....
9842	23411	Machine Base Screw Stud Nut Washer (3).....
132594	23075	Machine Base Thumb Screw Bushing.....
132592	23411	Machine Base complete, Nos. 132593, 132596, 132618, 132647, three each 9842, 51576E, 54477 and four each 935E, 42088, 66707 and 132595.....
132704	23411	Machine Base and Oil Drain Jar complete, Nos. 131268 and 132592.....

### MACHINE BASE No. 132656

(When Machine is mounted 1-1/2 in. lower than standard)  
FOR USE WITH BENCH STAND No. 79790

132655	23412	Machine Base.....
132595	23412	Machine Base Cushion (felt, large) (4).....
42088	23412	Machine Base Cushion (felt, small) (4).....
132618	23412	Machine Base Cushion (felt, small).....
935E	23412	Machine Base Cushion (felt, small) Screw (4).....
66707	23412	Machine Base Cushion (felt, small) Screw Washer (4).....
132596	23412	Machine Base Cushion (leather).....
132593	23412	Machine Base Oil Drain Strainer.....
1204E	23412	Machine Base Position Stud (3).....
131022	23412	Machine Base Position Stud Bushing (rubber) (3).....
132594	23075	Machine Base Thumb Screw Bushing.....
132656	23412	Machine Base complete, Nos. 132593, 132596, 132618, 132655, three each 1204E, 131022 and four each 935E, 42088, 66707 and 132595.....
132705	23412	Machine Base and Oil Drain Jar complete, Nos. 132656 and 132697.....

### MACHINE BASE OIL DRAIN JARS

(swinging type)  
OIL DRAIN JAR No. 131268, FOR MACHINE BASE No. 132592  
FOR BENCH STAND No. 79768

131961	23411	Jar (glass) 2-1/8 in. diam. at mouth.....
131962	23411	Jar Cap (diam. of recess for jar 2-7/16 in.).....
131188	23411	Jar Clamp.....
131217	.....	Jar Clamp 131188 with 131189.....
131189	23411	Jar Clamp Lever.....
1247C	23411	Jar Clamp Lever Hinge Screw (2).....
131265	23411	Nipple (long) (2).....
131266	23411	Nipple (short).....
131267	23411	Nipple Elbow (2).....
131268	23411	Machine Base Oil Drain Jar (swinging type) complete, Nos. 131217, 131266, 131961, 131962 and two each 1247C, 131265 and 131267.....

Film file library of Diamond Needle Corp

## MACHINE BASE OIL DRAIN JARS

(swinging type)

OIL DRAIN JAR No. 132697, FOR MACHINE BASE No. 132656

FOR BENCH STAND No. 79790

No.	Plate	Name
131961	23412	Jar (glass) 2-1/8 in. diam. at mouth.....
131962	23412	Jar Cap (diam. for recess of jar 2-7/16 in.).....
131188	23412	Jar Clamp.....
131217	.....	Jar Clamp 131188 with 131189.....
131189	23412	Jar Clamp Lever.....
1247C	23412	Jar Clamp Lever Hinge Screw (2).....
131265	23412	Nipple (long).....
131266	23412	Nipple (short) (2).....
131267	23412	Nipple Elbow (2).....
132697	23412	Machine Base Oil Drain Jar (swinging type) complete, Nos. 131217, 131265, 131961, 131962 and two each 1247C, 131266 and 131267.....

## THREAD UNWINDER

FOR THREE SPOOLS

225259	23413	Spool Rest (for one spool) with 201018C, 201528X, 228692 and 228693.....
225257	23413	Spool Rest (for two spools) with 201018C, two each 201528X, 228692 and 228693.....
150203	23413	Spool Rest Cushion (felt) (3).....
228692	23413	Spool Pin (3).....
201528X	.....	Spool Pin Nut (3).....
228693	.....	Spool Pin Washer (3).....
225388	23413	Spool Rest Rod.....
200383C	23413	Spool Rest Rod Set Screw.....
201018C	23413	Spool Rest Set Screw (2).....
259658	23413	Spool Stand with 200383C.....
225391	23413	Thread Guide (3).....
201696J	23413	Thread Guide Lock Nut.....
225326	23413	Thread Guide Position Cup.....
225324	23413	Thread Guide Rod with 208AL and 225322.....
208AL	23413	Thread Guide Rod Screw.....
225322	23413	Thread Guide Rod Screw Washer.....
150058	23413	Thread Separator with Bracket.....
150060	23413	Thread Separator Bracket Arm with 164J and 9525.....
164J	23413	Thread Separator Bracket Arm Clamping Screw.....
9525	23413	Thread Separator Bracket Arm Clamping Screw Washer.....
164J	23413	Thread Separator Bracket Screw.....
9525	23413	Thread Separator Bracket Screw Washer.....
150061	.....	Thread Separator complete, Nos 164J, 9525, 150058 and 150060.....
150178	23413	Thread Unwinder complete, Nos. 150061, 201696J, 225257, 225259, 225324, 225326, 225388, 259658 and three each 150203, 225391 and wood screws 7/8 in. No. 12.....
27739	.....	Thread Cone (wood) for large Cones.....
225390	.....	Thread Cone Holder, for inverted cones.....

NOTE: Nos. 27739 and 225390 are used with, but not included in No. 150178.

## NUMERICAL LIST OF PARTS

No.	Plate	Name
85D	23404	Presser Lever Lifter Hinge Screw.....
93AL	23408	Needle Bar Thread Retainer Screw for 137273.....
133F	23407	Knife (movable) Holder Screw for 132927.....
157E	23404	Feed Rock Shaft Crank Clamping Screw for 42021.....
164J	23413	Thread Unwinder Thread Separator Bracket Arm Clamping Screw for 150060.....
164J	23413	Thread Unwinder Thread Separator Bracket Screw for 150061.....
171AL	23405	Feed Connecting Rod Hinge Screw Clamping Screw for 132937.....
171F	23407	Needle Guard Screw.....
175E	23407	Knife (movable) Lever Connection Hinge Stud Set Screw for 132821.....
176J	23074	Frame Top Cover Extension Screw for 132600.....
176J	23405	Thread (looper, left hand) Nipper Spring Screw.....
176J	23408	Thread (looper, right hand) Staple Screw.....
185J	23408	Thread (looper, right hand) Take-up Screw.....
190J	23406	Feed Dog Screw.....
190E	23075	Frame Bottom Cover Screw.....
197J	23075	Frame Top Cover Oil Reservoir Cover Screw for 132947.....
197J	23408	Looper (right hand) Screw.....
197J	23408	Spreader Screw (for two-thread stitch).....
197J	23408	Thread (needle) Take-up Screw.....
201J	23405	Feed Eccentric Clamping Washer Screw for 132644.....
207J	23075	Thread (looper, left hand) Pull-off Eyelet Screw.....
208AL	23413	Thread Unwinder Thread Guide Rod Screw for 225324.....
217J	23408	Needle Bar Bushing (upper) Oil Pad Cover Screw.....
220E	23407	Knife (movable) Holder Cap Screw for 132927.....
223C	23405	Looper (right hand) and Spreader Lever Connection Roller Bearing Housing Clamping Screw for 132960.....
223F	23408	Needle Bar Connecting Link Hinge Pin Set Screw for 132740.....
223J	23408	Thread (needle) Eyelet Screw.....
233E	23075	Cloth Plate Extension (lower) Screw for 132963.....
233E	23075	Cloth Plate Extension (upper) Screw for 132963.....
233J	23406	Presser Foot Chaining-off Finger Screw for 132973.....
233E	23408	Thread (looper, left hand) Eyelet Screw for 132799.....
236C	23075	Cloth Plate Lock Spring Screw for 132963.....
240C	23406	Presser Foot Chaining-off Plate Collar Set Screw for 132610.....
241E	23408	Looper (right hand) and Spreader Lever Oil Plug Screw for 132799.....
283W	23074	Frame Top Cover Extension Holder Thumb Screw.....
330W	23075	Frame Side Cover (left) Screw.....
330W	23075	Frame Side Cover (right) Screw.....
336F	23407	Knife (movable) Holder Cap Guide Set Screw for 42038.....
356C	23037	Knee Lifter Rock Shaft Knee Arm Hub Set Screw for 2766.....
356C	23037	Knee Lifter Rock Shaft Knee Plate Set Screw for 2767.....
356C	23037	Knee Lifter Rock Shaft Lifting Bracket Hook Set Screw for 6337.....
356C	23037	Knee Lifter Rock Shaft Lifting Bracket Set Screw for 6337.....
440AL	23407	Knife (stationary) Holder Stop Screw.....
448AL	23405	Machine Driving Pulley Set Screw for 132925.....
462AL	23405	Feed Lifting Eccentric Set Screw for 132965.....
462AL	23408	Needle Bar Bushing Set Screw for 132724.....
462AL	23404	Thread (looper, left hand) Tube Set Screw.....
583F	23075	Frame Top Cover Screw (large).....
620AL	23408	Needle Bar Connecting Link Hinge Pin Set Screw for 132880.....
621E	23407	Knife (movable) Holder Cap Guide Plate Screw.....
624AL	23408	Needle Bar Crank (back) Bushing Set Screw for 132724.....
735AL	23406	Presser Foot Chaining-off Plate Collar Guide Pin Set Screw for 132972.....

## NUMERICAL LIST OF PARTS

No.	Plate	Name
742F	23075	Frame Top Cover Screw (small).....
742F	23406	Throat Plate Screw.....
896AL	23405	Needle Bar Connecting Rod Cap (lower) Screw for 132806.
896AL	23405	Needle Bar Connecting Rod Cap (upper) Screw for 132806.....
935E	23411	Machine Base Cushion (felt, small) Screw for 132592 and 132656.....
949E	23074	Arm Screw.....
1036AL	23405	Feed Eccentric Body Set Screw for 132644.....
1036AL	23404	Feed Rock Shaft Hinge Pin Bushing Set Screw.....
1036AL	23405	Frame Rotary Shaft Crank Set Screw for 132954.....
1036AL	23408	Looper (left hand) Lever Hinge Stud Set Screw.....
1036AL	23408	Looper (right hand) and Spreader Lever Hinge Pin Bushing Set Screw.....
1036AL	23408	Looper (right hand) and Spreader Lever Hinge Pin Set Screw.....
1057AL	23405	Feed Connecting Rod Cap Screw for 132937.....
1057AL	23405	Knife (movable) Lever Connection Cap Screw for 132966.....
1057AL	23405	Looper (right hand) and Spreader Lever Connection Cap Screw for 132956.....
1057AL	23408	Needle Bar Connecting Bracket Clamping Screw for 132740.....
1101C	23407	Knife (stationary) Holder Screw.....
1120AL	23404	Presser Lever Hinge Stud Set Screw.....
1148AL	23410	Foot Lifter Lifting Lever Stop Screw for 42133.....
1148F	23037	Knee Lifter Lifting Lever Stop Screw for 42144.....
1204E	23412	Machine Base Position Stud for 132656.....
1229C	23407	Knife (movable) Lever Hinge Stud Set Screw.....
1229C	23410	Foot Lifter Lifting Lever Bracket Screw for 42133.....
1229C	23037	Knee Lifter Lifting Lever Bracket Screw for 42144.....
1247C	23411	Machine Base Oil Drain Jar Clamp Lever Hinge Screw for 131268 and 132697.....
1253AL	23404	Feed Bar Hinge Pin Set Screw for 42205.....
1259AL	23408	Needle Bar Crank (back) Ball Stud Set Screw for 132879.....
1299AL	23405	Machine Driving Pulley Position Screw for 132925.....
1301D	23410	Foot Lifter Lifting Lever Hinge Screw for 42133.....
1301D	23037	Knee Lifter Lifting Lever Hinge Screw for 42144.....
1324C	23406	Presser Foot Screw.....
1375AL	23405	Frame Rotary Shaft Crank Position Screw for 132954.....
1376C	23407	Knife (stationary) Holder Regulating Thumb Screw.....
1377C	23404	Presser Lever Screw Stud (eccentric).....
1378D	23404	Pressure Regulating Thumb Screw.....
1520J	23405	Feed Connecting Rod Hinge Screw Nut.....
1534D	23407	Knife (stationary) Clamping Stud Thumb Nut.....
1547J	23407	Knife (stationary) Holder Stop Screw Nut.....
1547J	23404	Presser Lever Screw Stud Nut.....
1547J	23410	Foot Lifter Lifting Lever Stop Screw Nut for 42133.....
1547J	23037	Knee Lifter Lifting Lever Stop Screw Nut for 42144.....
1664E	23405	Looper (right hand) and Spreader Lever Connection Roller Bearing Retaining Nut Lock Nut for 132958.....
1695J	23405	Feed Connecting Rod Hinge Screw Clamping Screw Nut for 132937.....
1735J	23408	Looper (left hand) Lever Connecting Link Screw Nut for 132801.....
1737C	23408	Needle Clamping Nut.....
2102	23074	Tension (looper, left hand) Disc.....
2102	23074	Tension (looper, right hand) Disc.....
2102	23074	Tension (needle thread) Disc.....
2763	23037	Knee Lifter Rock Shaft for 42143.....
2765	23037	Knee Lifter Rock Shaft Knee Arm for 2768.....
2766	23037	Knee Lifter Rock Shaft Knee Arm Hub with 356C, for 2768.....
2767	23037	Knee Lifter Rock Shaft Knee Plate with 356C for 2768.....
2768	.....	Knee Lifter Rock Shaft Knee Arm complete, for 42143, Nos. 2765, 2766 and 2767.....

## NUMERICAL LIST OF PARTS

No.	Plate	Name
2770	23037	Knee Lifter Rock Shaft Stop Dog with 140219C for 42143.....
4389	23074	Arm Dowel Pin.....
4822	23409	Wrench for 1547 (Accessories).....
4879	23410	Foot Lifter Chain Connecting Link for 4885.....
4881	23410	Foot Lifter Treadle for 4885.....
4882	23410	Foot Lifter Treadle Shaft for 4885.....
4883	23410	Foot Lifter Treadle Spring for 4885.....
4884	23410	Foot Lifter Treadle Stand for 4885.....
4885	23410	Foot Lifter Treadle complete for 42133, Nos. 4879, 4881, 4882, 4883, 4884 and two wood screws 1 in. No. 16.....
6337	23037	Knee Lifter Rock Shaft Lifting Bracket with two 356C, for 42143.....
6439	23410	Foot Lifter Chain, 36 in. to 45 in. with 56864 and 56865, for 42133.....
7071	NOTE:	When ordering No. 6439, state length required.
7125	23408	Thread (looper, right hand) Staple Screw Washer.....
8908	23037	Knee Lifter Rock Shaft Lifting Bracket Hook for 42143.....
9525	23409	Wrench for 1520 (Accessories).....
9525	23413	Thread Unwinder Thread Separator Bracket Arm Clamping Screw Washer for 150060.....
9525	23413	Thread Unwinder Thread Separator Bracket Screw Washer for 150061.....
9842	23411	Machine Base Screw Stud Nut Washer for 132592.....
9842	23411	Machine Base Screw Stud Spring Washer (Accessories).....
10107	23408	Needle Bar Thread Retainer Spring for 132723.....
12242	23037	Knee Lifter Rock Shaft Hanger with two wood screws 1 in. No. 10, for 42143.....
14058	23406	Presser Foot Chaining-off Plate Spring for 132973.....
14063	23409	Machine Base Screw Stud Spring, for Screw Stud No. 137258, when machine is mounted on Individual Stand (Accessories).....
19044	23074	Frame Top Cover Extension Holder Thumb Screw Washer.....
19047	23405	Feed Eccentric Clamping Washer for 132644.....
22003	23409	Wrench (Accessories).....
27498	23409	Machine Base Screw Stud Spring, for Screw Stud No. 137260, when machine is mounted 1-1/2 in. lower than standard (Accessories).....
27739	.....	Thread Unwinder Thread Cone (wood) for large cones for use with No. 150178.....
27998	23409	Bench Stand Cover Hook and Eye (brass) with wood screw 1/2 in. No. 5 F.H. for 79768 and 79790.....
28291	23409	Bench Stand Cover Hinge with two each wood screws 1/2 in. No. 5 F.H. and 5/8 in. No. 5 F.H. for 79768 and 79790.....
38534	23408	Needle Bar (hollow).....
39541	23406	Presser Foot Screw Washer.....
42005	23075	Cloth Plate Lock Spring for 132963.....
42021	23404	Feed Rock Shaft Crank with 157E for 132626.....
42028	23075	Frame Side Cover (right) hinged.....
42038	23407	Knife (movable) Holder Cap Guide with 336F.....
42039	23407	Knife (movable) Holder Cap Guide Plate.....
42040	23407	Knife (movable) Holder Screw Extension Pin for 132927.....
42041	23407	Knife (movable) Holder Spring.....
42045	23407	Knife (movable) Lever Hinge Stud.....
42045	23404	Presser Lever Hinge Stud for 42377.....
42049	23407	Knife (stationary) Stud for 42309.....
42066	23407	Needle Guard.....
42070	23404	Presser Lever Lifter.....
42071	23404	Presser Lever Spring.....
42082	23074	Tension (needle thread) Thread Guide.....
42084	23404	Thread (looper, left hand) Tube.....
42088	23411	Machine Base Cushion (felt, small) for 132592 and 132656.....

## NUMERICAL LIST OF PARTS

No.	Plate	Name
42089	23409	Wrench for 1324 and 1737 (Accessories)
42090	23409	Threading Wire (Accessories)
42101	23074	Frame Side Cover (right) Lock Spring for 132600
42102	23074	Frame Top Cover Extension Holder for 132600
42108	23075	Cloth Plate Extension (upper) for 132963
42115	23408	Needle Bar Thread Retainer Bracket for 132723
42122	23405	Thread (looper, left hand) Nipper Spring (lower)
42123	23405	Thread (looper, left hand) Nipper Spring (upper)
42126	23405	Thread (looper, right hand) Pull-off
42130	23410	Foot Lifter Lifting Lever for 42133
42130	23037	Knee Lifter Lifting Lever for 42144
42131	23410	Foot Lifter Lifting Lever Bracket for 42133
42131	23037	Knee Lifter Lifting Lever Bracket for 42144
42132	23410	Foot Lifter Lifting Lever Spring for 42133
42132	23037	Knee Lifter Lifting Lever Spring for 42144
42133	23410	Foot Lifter complete, Nos. 1301D, 4885, 6439, 42130, 42131, 42132 and two each 1148AL, 1229C and 1547J
42142	23037	Knee Lifter Lifting Lever Connecting Rod for 42144
42143	23037	Knee Lifter Rock Shaft complete, for 42144, Nos. 2763, 2768, 6337, 7125 and two each 2770 and 12242
42144	23037	Knee Lifter complete, Nos. 1301D, 42130, 42131, 42132, 42142, 42143 and two each 1148F, 1229C and 1547J
42205	23404	Feed Bar with 1253AL for 132642
42227	23404	Presser Lever for 42377
42242	23408	Thread (looper, left hand) Eyelet for 132801
42244	23075	Thread (looper, left hand) Pull-off Eyelet
42305	23407	Knife (movable)
		NOTE: Two No. 42305 are sent with this Machine.
42306	23407	Knife (movable) Gib for 132927
42309	23407	Knife (stationary) with 42049
		NOTE: Two No. 42309 are sent with this Machine.
42310	23407	Knife (stationary) Clamping Stud
42377		Presser Lever 42227 with 42045
42461	23406	Presser Foot Hinge Pin for 132973
42483	23408	Needle Bar Thread Retainer Disc for 132723
46548	23409	Bench Stand Cover Rest (felt) for 79768 and 79790
50117AL	23408	Looper (left hand) Clamping Screw for 132795
50148C	23074	Tension (looper, right hand) Screw Stud for 132871
50150AL	23075	Cloth Plate Hinge Stud Set Screw
50200C	23408	Needle Bar Crank (front) Set Screw for 132880
50253J	23074	Feed Eccentric Cover Screw for 132600
50261C	23074	Tension (needle thread) Screw Stud for 132360
50326C	23074	Tension (looper, left hand) Screw Stud for 59539
51145C	23405	Feed Regulating Screw for 132644
51292C	23405	Feed Connecting Rod Hinge Screw
51332C	23405	Frame Rotary Shaft Bushing (front) Set Screw
51332C	23405	Frame Rotary Shaft Flanged Bushing (back) Set Screw
51459E	23408	Looper (left hand) Lever Connecting Link Screw for 132801
51570C	23074	Tension (looper, left hand) Regulating Thumb Nut for 59539
51570C	23074	Tension (looper, right hand) Regulating Thumb Nut for 132871
51570C	23074	Tension (needle thread) Regulating Thumb Nut for 132360
51576E	23411	Machine Base Screw Stud Nut for 132592
51736C	23405	Looper (right hand) and Spreader Lever Connection Roller Bearing Retaining Nut for 132958
51756E	23409	Machine Base Screw Stud Wing Nut for 132759 and 137261
52130	23408	Thread (needle) Eyelet Bushing for 132873
54477	23411	Machine Base Screw Stud for 132592
56864	23410	Foot Lifter Chain Hook (large) for 6439
56865	23409	Bench Stand Cover Chain Hook for 60820

## NUMERICAL LIST OF PARTS

No.	Plate	Name
56865	23410	Foot Lifter Chain Hook (small) for 6439
59534	23074	Tension (looper, left hand) Spring
59535	23074	Tension (looper, right hand) Spring
59537	23074	Tension (looper, left hand) Spring Bushing (large)
59537	23074	Tension (looper, right hand) Spring Bushing (large)
59537	23074	Tension (needle thread) Spring Bushing (large)
59538	23074	Tension (looper, left hand) Spring Bushing (small)
59538	23074	Tension (looper, right hand) Spring Bushing (small)
59538	23074	Tension (needle thread) Spring Bushing (small)
59539		Tension (looper, left hand) Screw Stud 50326C with 51570C
60820	23409	Bench Stand Cover Chain, 9-1/4 in. long with two 56865, for 79790
66707	23411	Machine Base Cushion (felt, small) Screw Washer for 132592 and 132656
68350	23074	Arm Oil Cup
68497		Feed Connecting Rod Oil Pad for 132937
79768		Bench Stand with 27998, two each 28291, 46548 and wood screws 1-1/2 in. No. 14 F.H. for use with 132592, for use when mounted on top of table
79790		Bench Stand with 27998, 60820, two each 28291, 46548, 150244 and three each wood screws 1-1/4 in. No. 12 F.H. and 1-1/2 in. No. 14 F.H., for use with Machine Base No. 132656, for use when machine is mounted 1-1/2 in. lower than standard
120341	23409	Tweezers (curved) Accessories
120344	23409	Oiler with 120345 (Accessories)
120345	23409	Oiler Spout for 120344
120440	23409	Screw Driver (Accessories)
125056	23408	Looper (right hand) and Spreader Lever Hinge Pin Oil Pad (braided cotton) for 132699
131022	23412	Machine Base Position Stud Bushing (rubber) for 132656
131188	23411	Machine Base Oil Drain Jar Clamp for 131217
131189	23411	Machine Base Oil Drain Jar Clamp Lever for 131217
131217		Machine Base Oil Drain Jar Clamp 131188 with 131189, for 131268 and 132697
131265	23411	Machine Base Oil Drain Jar Nipple (long) for 131268 and 132697
131266	23411	Machine Base Oil Drain Jar Nipple (short) for 131268 and 132697
131267	23411	Machine Base Oil Drain Jar Nipple Elbow for 131268 and 132697
131268	23411	Machine Base Oil Drain Jar (swinging type) complete, for 132704, Nos. 131217, 131266, 131961, 131962 and two each 1247C, 131265 and 131267
131696	23074	Tension (looper, right hand) Thread Guide
131740	23074	Tension (needle thread) Spring
131961	23411	Machine Base Oil Drain Jar (glass) 2-1/8 in. diam. at mouth for 131268 and 132697
131962	23411	Machine Base Oil Drain Jar Cap (diam. of recess for jar 2-7/16 in.) for 131268 and 132697
132360		Tension (needle thread) Screw Stud 50261C with 51570C
122526	23075	Cloth Plate Hinge Stud
132528	23404	Feed Bar Hinge Pin
132533	23405	Feed Eccentric Oil Tube for 132644
132537	23405	Feed Eccentric Lubricator Oil Wick (braided cotton) for 132785
132539	23405	Feed Lifting Eccentric Connection for 132642
132542	23404	Feed Rock Shaft Hinge Pin with 132544
132543	23404	Feed Rock Shaft Hinge Pin Bushing
132543	23408	Looper (right hand) and Spreader Lever Hinge Pin Bushing
132544	23404	Feed Rock Shaft Hinge Pin Oil Wick (braided cotton) for 132542

No.	Plate	Name
*132545		Frame
132546	23075	Frame Bottom Cover with 132594
132547	23075	Frame Bottom Cover Gasket
132548	23074	Frame Oil Cup
132552	23408	Looper (left hand) Lever Hinge Stud Oil Pad (braided cotton) for 132798
132558	23405	Frame Rotary Shaft Oil Pad (wick) for 132788
132559	23405	Frame Rotary Shaft Oil Pad Retainer for 132788
132560	23075	Frame Side Cover (left) with 132701
132565	23405	Knife (movable) Lever Connection Hinge Stud
132580	23408	Needle Bar Bushing (upper) for 132724
132581	23408	Needle Bar Bushing (upper) Oil Pad (braided cotton)
132582	23408	Needle Bar Connecting Link for 132881
132583	23408	Needle Bar Connecting Link Hinge Pin with 132584, for 132881
132584	23408	Needle Bar Connecting Link Hinge Pin Oil Pad (wick) for 132583
132589	23408	Needle Bar Crank (back) Bushing for 132724
132590	23408	Needle Bar Crank (back) Oil Pad (wick) for 132879
132591	23405	Thread (looper, left hand) Pull-off
132592	23411	Machine Base complete, for 132704, Nos. 132593, 132596, 132618, 132647, three each 9842, 51576E, 54477 and four each 935E, 42088, 66707 and 132595
132593	23411	Machine Base Oil Drain Strainer for 132592 and 132656
132594	23075	Machine Base Thumb Screw Bushing for 132546
132595	23411	Machine Base Cushion (felt, large) for 132592 and 132656
132596	23411	Machine Base Cushion (leather) for 132592 and 132656
132599	23074	Tension (looper, left hand) Thread Guide
132600	23074	Frame Top Cover Extension Holder 42102 with 42101, 132650, 132651 and two each 176J and 50253J
132601	23075	Cloth Plate Extension (lower) for 132963
132602	23409	Machine Base Screw Stud Washer (Accessories)
132603	23405	Frame Rotary Shaft Flanged Bushing (back) Oil Pad Retainer for 132866
132610	23406	Presser Foot Chaining-off Plate Collar with 240C for 132973
132611	23406	Presser Foot Chaining-off Plate Collar Guide Pin for 132973
132618	23411	Machine Base Cushion (felt, small) for 132592 and 132656
132621	23408	Needle Bar Bushing (upper) Oil Pad Cover
132623	23408	Thread (needle) Take-up
132625	23404	Feed Rock Shaft for 132626
132626		Feed Rock Shaft complete, Nos. 42021 and 132625
132642		Feed Bar 42205 with 132539
132644	23405	Feed Eccentric complete, for 132938, Nos. 201J, 19047, 51145C, 132533 and two 1036AL
132647	23411	Machine Base for 132592
132650	23074	Frame Top Cover Extension for 132600
132651	23074	Feed Eccentric Cover for 132600
132654	23075	Chip Guard
132655	23412	Machine Base for 132656
132656	23412	Machine Base complete, for 132705, Nos. 132593, 132596, 132618, 132655, three each 1204E, 131022 and four each 935E, 42088, 66707 and 132595
132664	23408	Thread (looper, right hand) Staple
132692	23405	Frame Rotary Shaft Oil Sling Cover for 132866
132697	23412	Machine Base Oil Drain Jar (swinging type) complete, for 132705, Nos. 131217, 131265, 131961, 131962 and two each 1247C, 131266 and 131267
132699	23408	Looper (right hand) and Spreader Lever Hinge Pin with 125056 for 132800

No.	Plate	Name
132701	23075	Frame Side Cover (left) Handle for 132560
132704	23411	Machine-Base and Oil Drain Jar complete, for Machine Base No. 132592, when machine is mounted on top of table, for use with Bench Stand No. 79768, Nos. 131268 and 132592
132705	23412	Machine Base and Oil Drain Jar complete, for Machine Base No. 132656, when machine is mounted 1-1/2 in. lower than standard, for use with Bench Stand No. 79790, Nos. 132656 and 132697
132712	23405	Feed Eccentric Lint Cover (spring)
132715	23405	Frame Rotary Shaft Bushing (front) Oil Pad Retainer for 132810
*132724		Arm with 132580, 132739 and two each 462AL, 624AL and 132589
132739	23408	Needle Bar Bushing (lower) for 132724
132740	23408	Needle Bar Connecting Bracket with 223F and 1057AL, for 132881
132767	23407	Knife (stationary) Holder
132776	23405	Looper (right hand) and Spreader Lever Ball Stud for 132958
132783	23075	Frame Top Cover Oil Tube (long) for 132947
132784	23075	Frame Top Cover Oil Tube Wick for 132947
132785	23045	Feed Eccentric Lubricator with 132537
132788	23405	Frame Rotary Shaft with 132558 and 132559, for 132789
132789		Frame Rotary Shaft 132788 with 132790, 132802, 132806 and 132932
132790	23405	Frame Rotary Shaft Ball Sleeve (two pieces) for 132789
132795	23408	Looper (left hand) Lever with 50117AL, for 132801
132796	23408	Looper (left hand) Lever Connecting Link for 132801
132797	23408	Looper (left hand) Lever Connecting Link Hinge Pin for 132801
132798	23408	Looper (left hand) Lever Hinge Stud with 132552, for 132801
132799	23408	Looper (right hand) and Spreader Lever with 233E, 241E and 140123AL for 132800
132800		Looper (right hand) and Spreader Lever 132799 with 132699, for 132801
132801		Looper (right hand) and Spreader Lever 132800 with 42242, 132795, 132798 and two each 1735J, 51459E, 132796 and 132797
132802	23405	Needle Bar Crank (back) Ball Stud for 132789
132806	23405	Needle Bar Connecting Rod with four 896AL, for 132789
132810	23405	Frame Rotary Shaft Bushing (front) with 132835, 132864 and two 132715
132811	23408	Looper (left hand)
132812	23408	Thread (looper, right hand) Take-up
132816	23404	Feed Rock Shaft Hinge Pin Bushing Oil Wick
132816	23408	Looper (left hand) Lever Hinge Stud Oil Wick
132816	23408	Looper (right hand) and Spreader Lever Hinge Pin Bushing Oil Wick
132817	23405	Frame Rotary Shaft Bushing (front) Oil Wick
132817	23405	Frame Rotary Shaft Flanged Bushing (back) Oil Wick
132821	23407	Knife (movable) Lever with 175E
132824	23406	Throat Plate, for 132964
132835	23405	Frame Rotary Shaft Crank Oil Sling Cover for 132810
132864	23405	Frame Rotary Shaft Bushing (front) Oil Pad (braided cotton) for 132810
132865	23405	Frame Rotary Shaft Flanged Bushing (back) for 132866
132866		Frame Rotary Shaft Flanged Bushing (back) 132865 with 132692, 132867, 132868 and two 132603
132867	23405	Frame Rotary Shaft Flanged Bushing (back) Oil Pad (large) braided cotton for 132866
132868	23405	Frame Rotary Shaft Flanged Bushing (back) Oil Pad (small) braided cotton for 132866

## NUMERICAL LIST OF PARTS

No.	Plate	Name
132871		Tension (looper, right hand) Screw Stud 50148C with 51570C
132872	23405	Thread (looper, right hand) Controller
132873	23408	Thread (needle) Eyelet with 52130
132879	23408	Needle Bar Crank (back) with 132590 and two 1259AL
132880	23408	Needle Bar Crank (front) with 620AL, 50200C and 140123AL, for 132881
132881		Needle Bar Crank (front) 132880 with 132582, 132740 and two 132583
132925	23405	Machine Driving Pulley, "V" belt groove (outside diam. of belt groove 2.9 in.) with 448AL and 1299AL
132926	23407	Knife (movable) Holder for 132927
132927		Knife (movable) Holder 132926 with 133F, 42040, 42306, 132928 and two 220E
132928	23407	Knife (movable) Holder Cap for 132927
132932	23405	Frame Rotary Shaft Ball Sleeve Guide for 132789
132937	23405	Feed Connecting Rod with 171AL, 1695J, 68497, 134260 and two 1057AL, for 132938
132938		Feed Connecting Rod 132937 with 132644
132946	23075	Frame Top Cover with 132950, for 132947
132947		Frame Top Cover 132946 with 132783, 132784, 132948, 132952 and two 197J
132948	23075	Frame Top Cover Oil Reservoir Cover for 132947
132950	23075	Frame Top Cover Oil Tube (short) for 132946
132952	23075	Frame Top Cover Oil Tube Wick for 132947
132954	23405	Frame Rotary Shaft Crank with 1036AL and 1375AL, for 132958
132956	23405	Looper (right hand) and Spreader Lever Connection with two 1057AL, for 132958
132958		Looper (right hand) and Spreader Lever Connection 132956 with 1664E, 51736C, 132776, 132954, 132960, 132961, 143098 and sixteen 132959
132959	23405	Looper (right hand) and Spreader Lever Connection Roller Bearing for 132958
132960	23405	Looper (right hand) and Spreader Lever Connection Roller Bearing Housing with 223C, for 132958
132961	23405	Looper (right hand) and Spreader Lever Connection Roller Bearing Housing Hinge Pin for 132958
132962	23075	Cloth Plate with Hinge Bracket for 132963
132963	23075	Cloth Plate complete, Nos. 42005, 42108, 132601, 132962, two 236C and five 233E
132964	23406	Feed Dog, 26 teeth (16 teeth to the inch) for 132824
132965	23405	Feed Lifting Eccentric with two 462AL, for 132967
132966	23405	Knife (movable) Lever Connection with two 1057AL, for 132967
132967		Knife (movable) Lever Connection 132966 with 132965
132968	23408	Looper (right hand)
132969	23406	Presser Foot Chaining-off Finger for 132973
132970	23406	Presser Foot Chaining-off Plate for 132973
132971	23406	Presser Foot Plate for 132973
132972	23406	Presser Foot Shank with 735AL for 132973
132973	23406	Presser Foot (hinged) complete, for closing pockets and stitching over heavy seams in trousers, Nos. 233J, 14058, 42461, 132610, 132611, 132969, 132970, 132971 and 132972
132974	23408	Spreader (for two-thread stitch)
134260		Feed Connecting Rod Oil Pad Retainer for 132937
137258	23409	Machine Base Screw Stud for 137259
137259	23409	Machine Base Screw Stud 137258 with 51756E, for 1-5/8 in. Tables and Individual Stands, for use when machine is mounted on top of table (Accessories)
137260	23409	Machine Base Screw Stud for 137261

## NUMERICAL LIST OF PARTS

No.	Plate	Name
137261	23409	Machine Base Screw Stud 137260 with 51756E, for use when machine is mounted 1-1/2 in. lower than standard (Accessories)
137273		Needle Bar Thread Retainer complete, Nos. 93AL, 10107, 42115 and two 42483
140123AL	23408	Looper (right hand) and Spreader Lever Ball Stud Set Screw for 132799
140123AL	23408	Needle Bar Crank (front) Position Screw for 132880
140219C	23037	Knee Lifter Rock Shaft Stop Dog Set Screw for 2770
143098		Looper (right hand) and Spreader Lever Connection Roller Bearing Retaining Washer for 132958
150058	23413	Thread Unwinder Thread Separator with Bracket for 150061
150060	23413	Thread Unwinder Thread Separator Bracket Arm with 164J and 9525, for 150061
150061		Thread Unwinder Thread Separator complete, for 150178, Nos. 164J, 9525, 150058 and 150060
150178	23413	Thread Unwinder complete, for three spools, Nos. 150061, 201696J, 225257, 225259, 225324, 225326, 225388, 259658 and three each 150203, 225391 and wood screws 7/8 in. No. 12
150203	23413	Thread Unwinder Spool Rest Cushion (felt) for 150178
150244	23409	Bench Stand Cover Chain Hook Screw Eye for 79790
200383C	23413	Thread Unwinder Spool Rest Rod Set Screw for 259658
201018C	23413	Thread Unwinder Spool Rest Set Screw for 225257 and 225259
201528X		Thread Unwinder Spool Pin Nut for 225257 and 225259
201696J	23413	Thread Unwinder Thread Guide Lock Nut for 150178
225257	23413	Thread Unwinder Spool Rest (for two spools) with 201018C, two each 201528X, 228692 and 228693, for 150178
225259	23413	Thread Unwinder Spool Rest (for one spool) with 201018C, 201528X, 228692 and 228693, for 150178
225322	23413	Thread Unwinder Thread Guide Rod Screw Washer for 225324
225324	23413	Thread Unwinder Thread Guide Rod with 208AL and 225322, for 150178
225326	23413	Thread Unwinder Thread Guide Position Cup for 150178
225388	23413	Thread Unwinder Spool Rest Rod for 150178
225390		Thread Unwinder Thread Cone Holder for inverted cones for use with No. 150178
225391	23413	Thread Unwinder Thread Guide for 150178
228692	23413	Thread Unwinder Spool Pin for 225257 and 225259
228693		Thread Unwinder Spool Pin Washer for 225257 and 225259
259658	23413	Thread Unwinder Spool Stand with 200383C, for 150178

23037 - 1/3

42144

42143

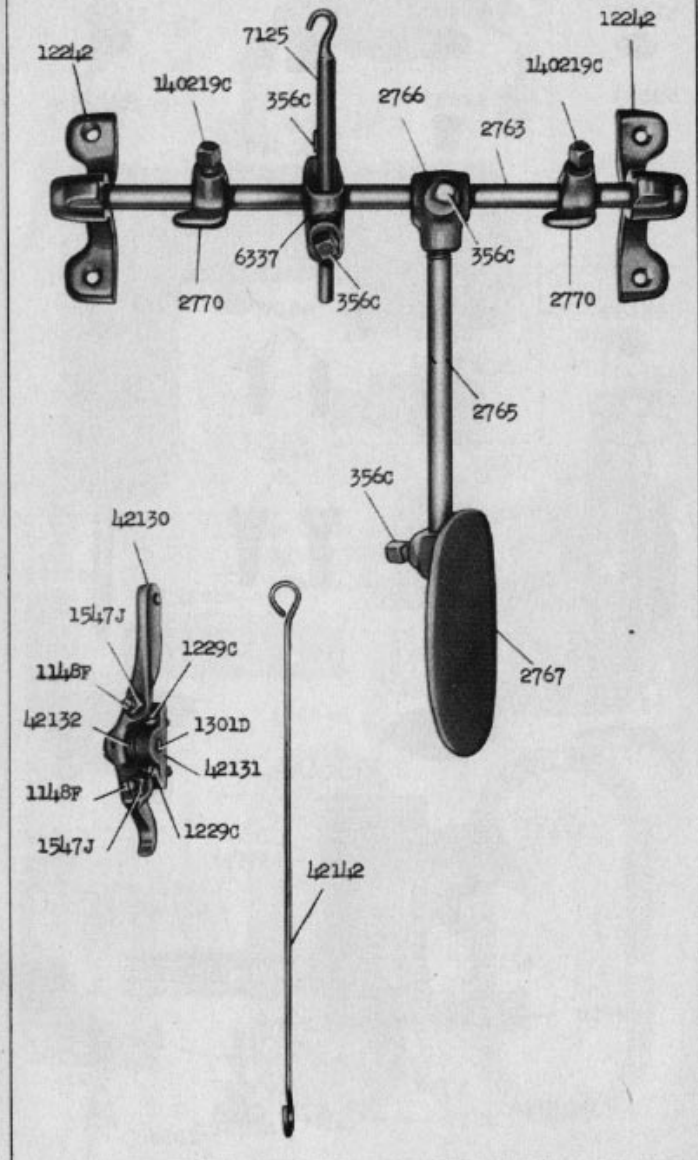

From the library of: Diamond Needle Corp

23074-1/2

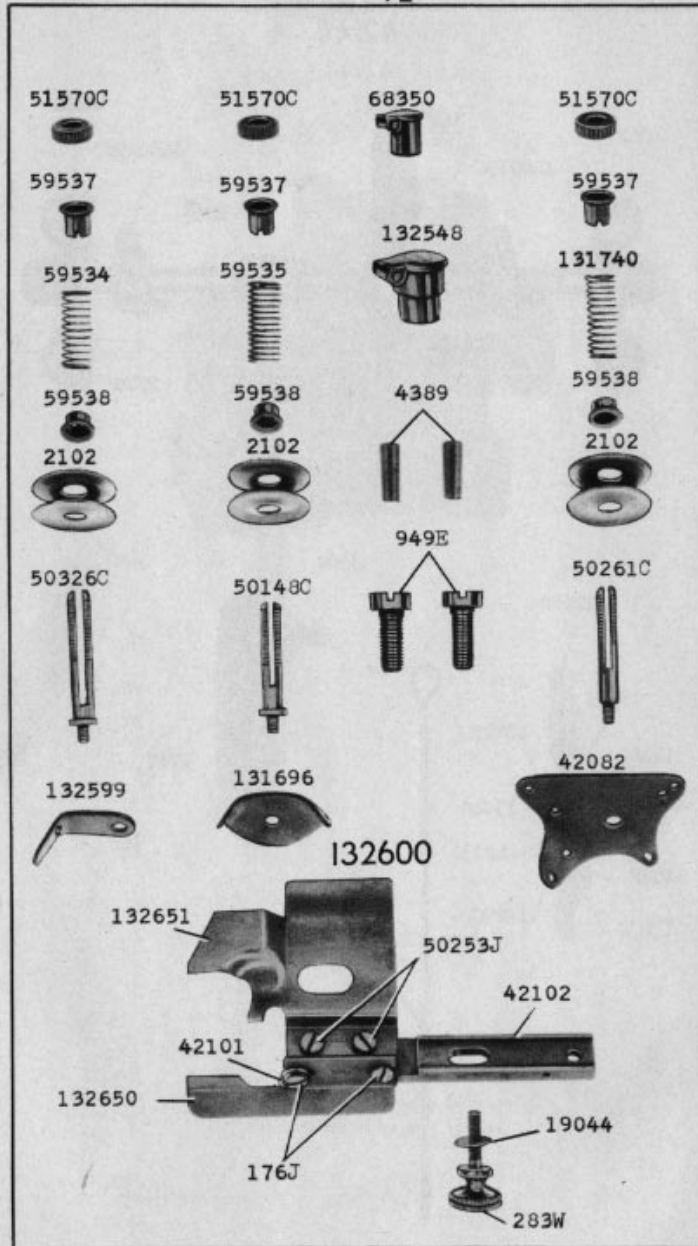

23075-1/3

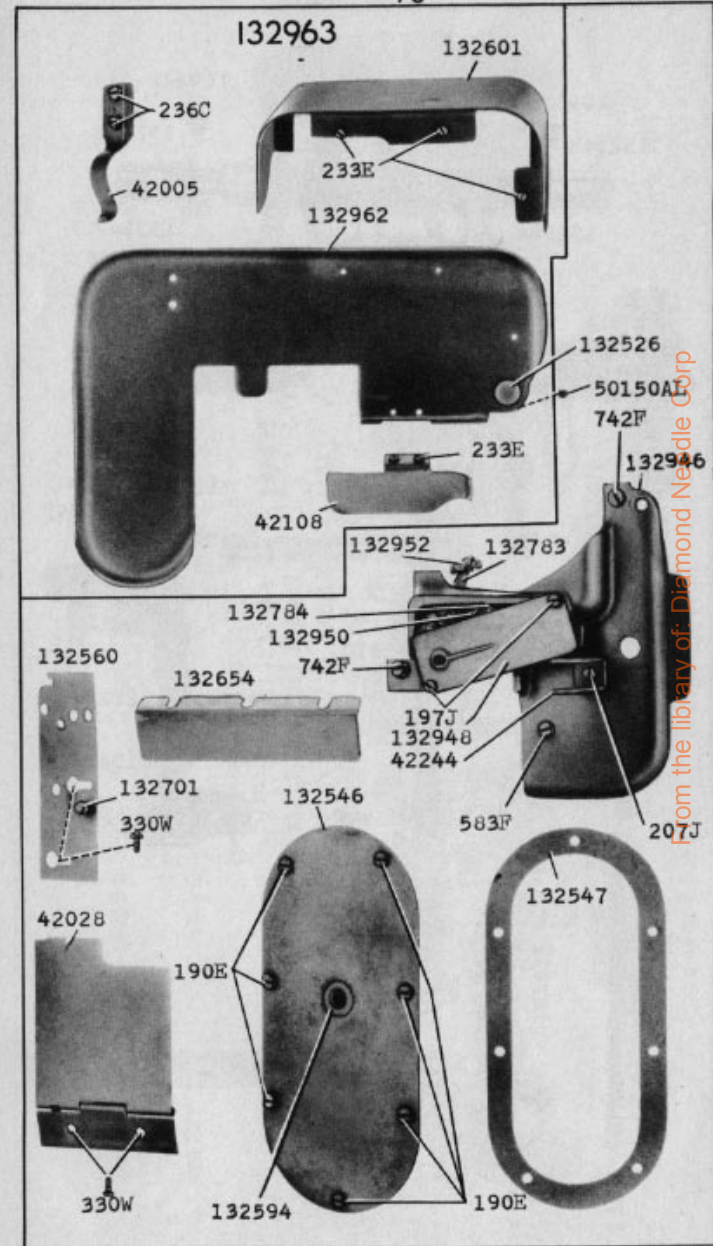

From the library of: Diamond Needle Corp



23404-1/2

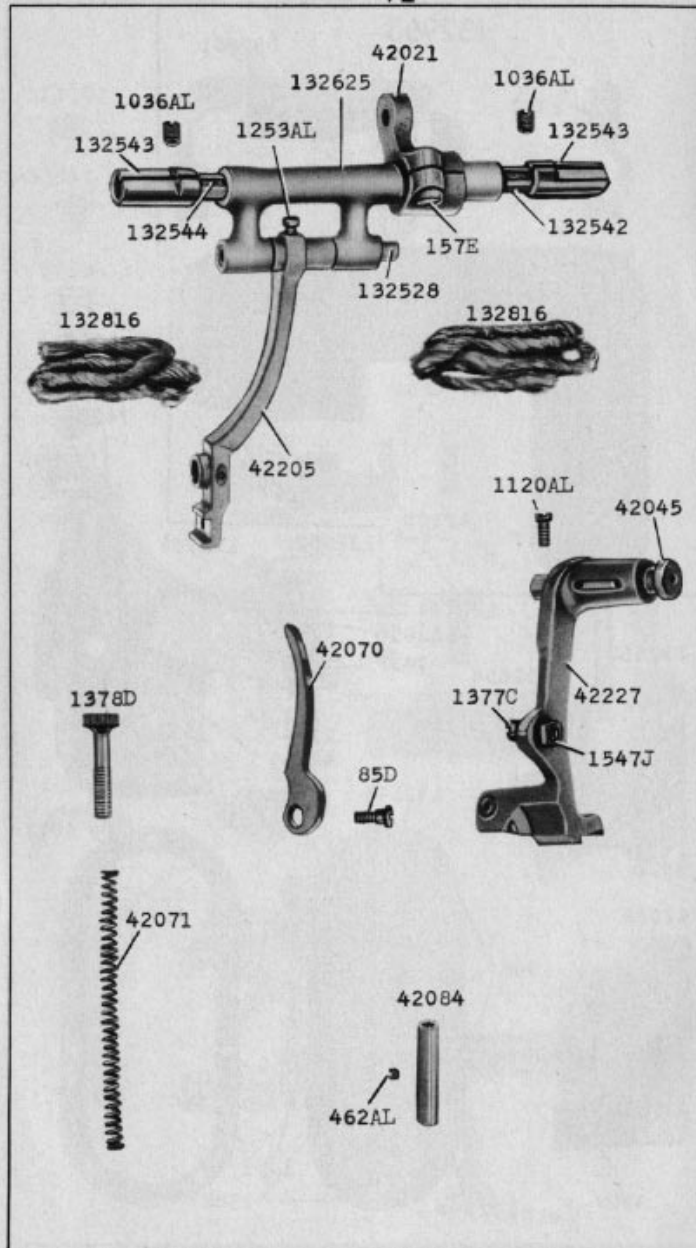

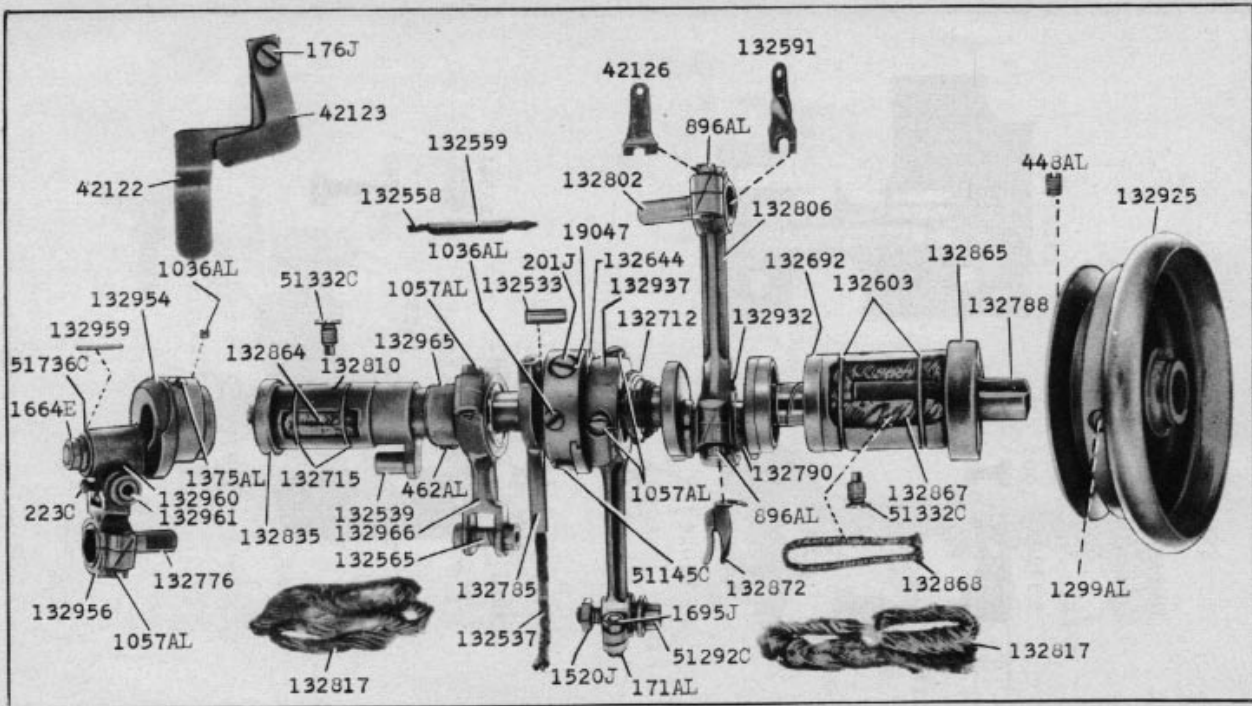

23405-1/2

23406-2/3

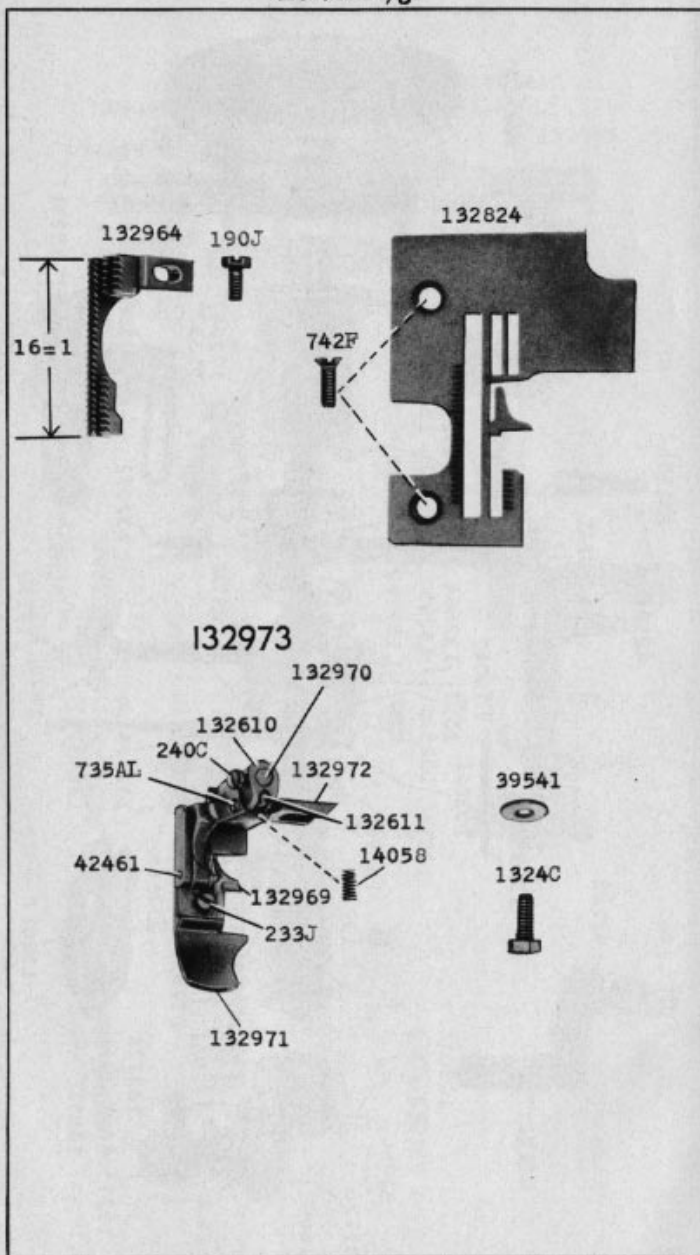

23407-2/3

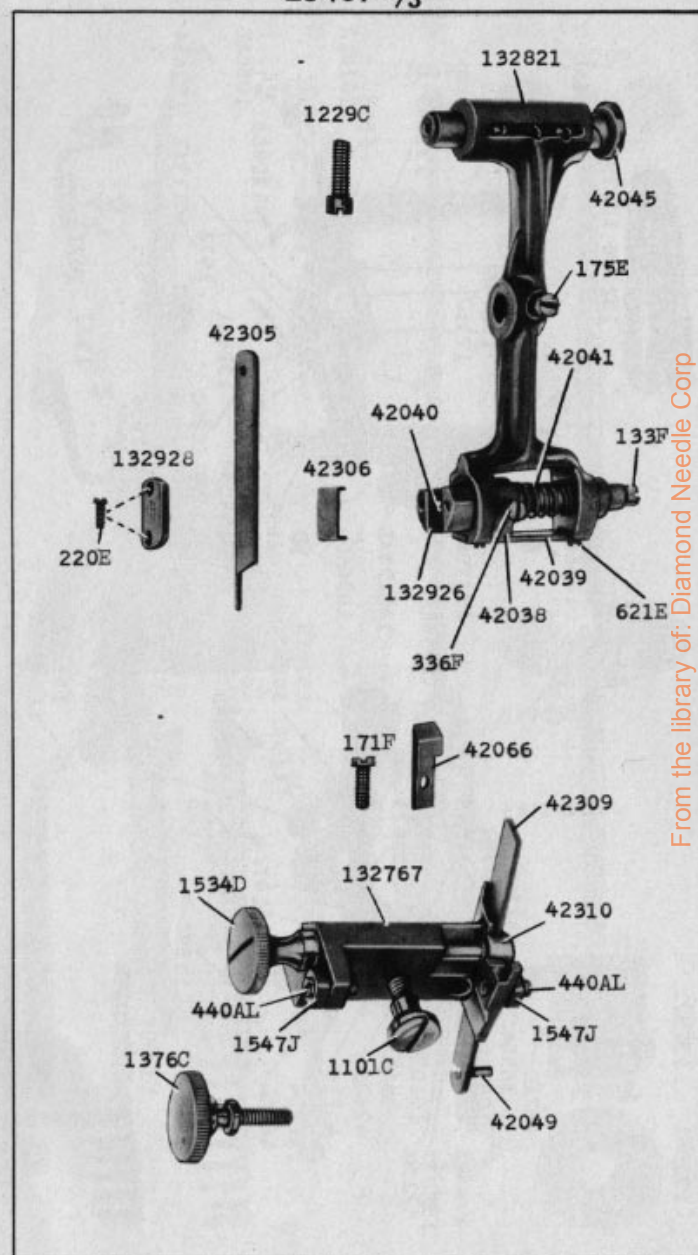

From the library of: Diamond Needle Corp

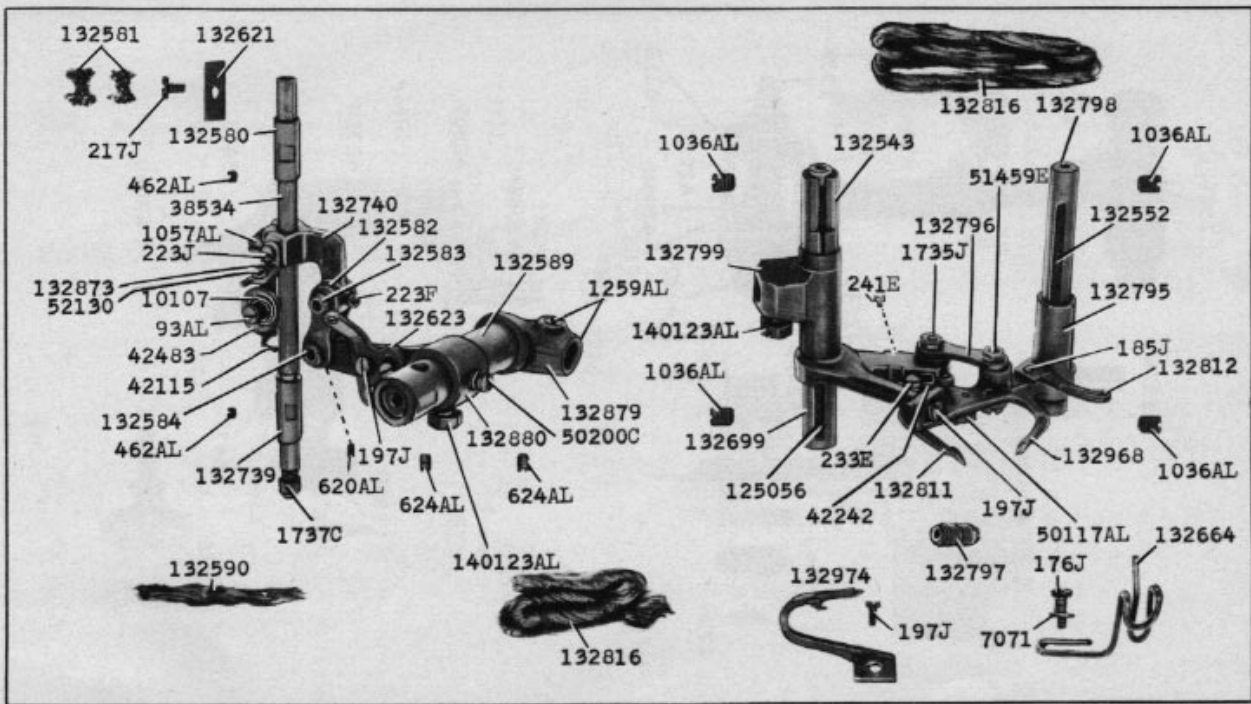

23408-1/2

23409-1/2

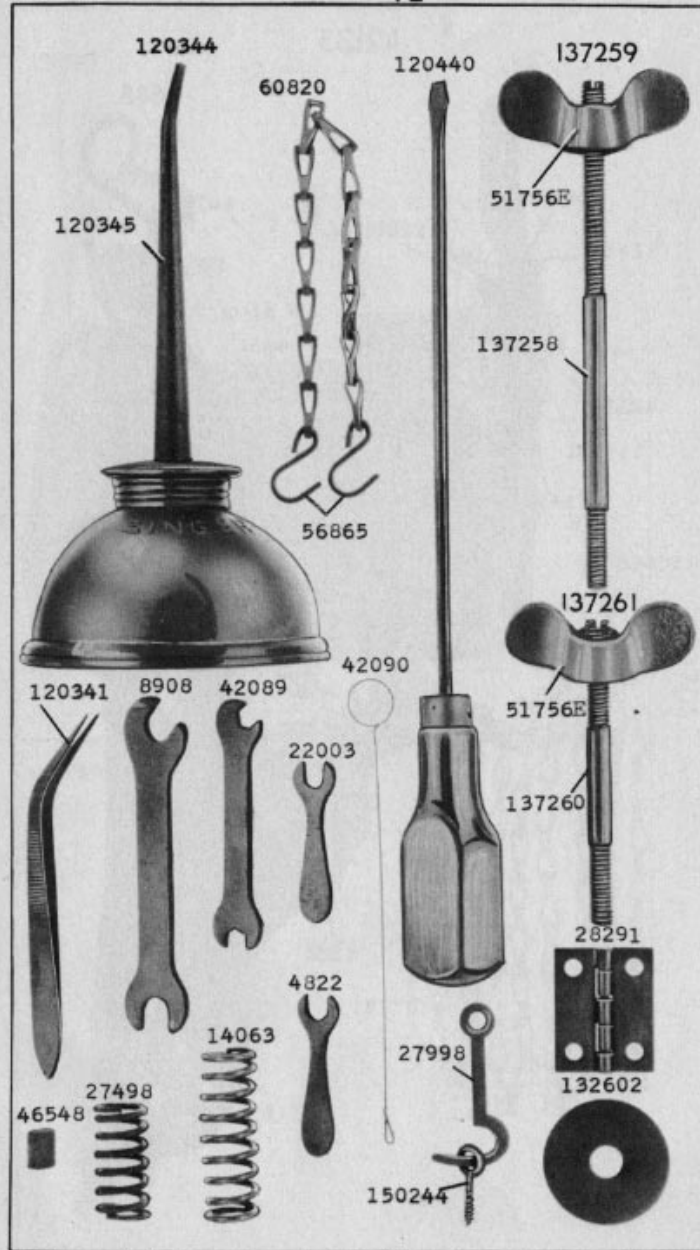

23410-1/2

42133

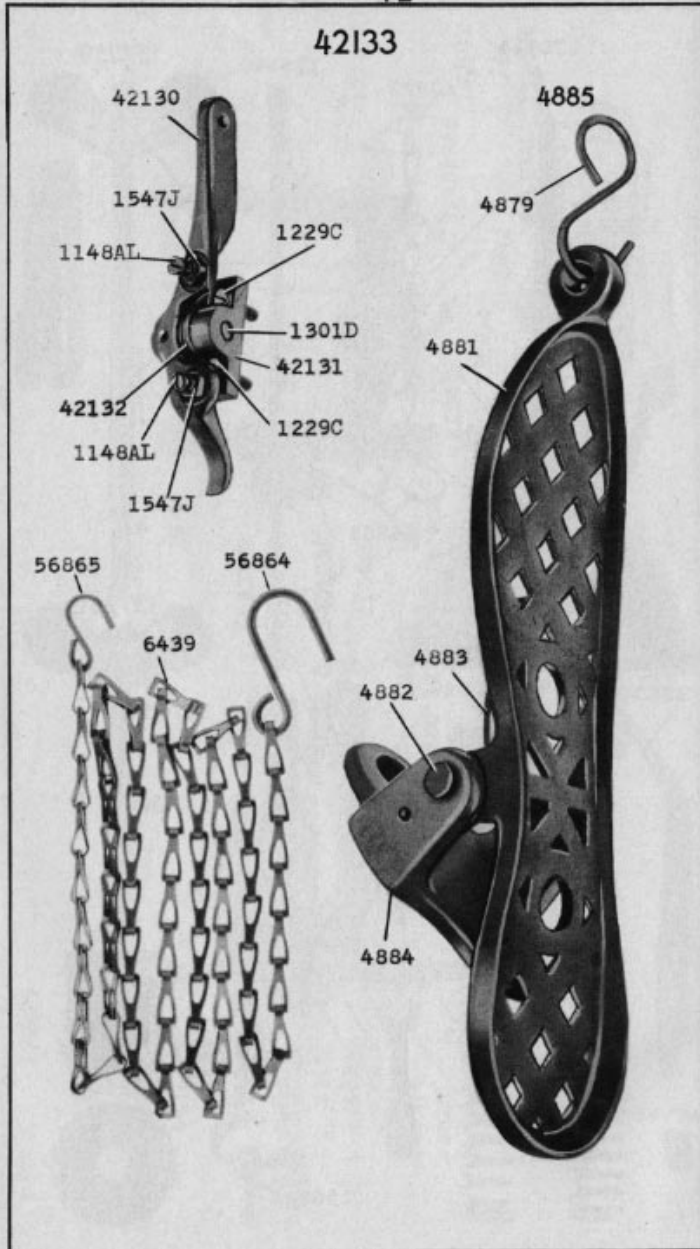

23411-1/3

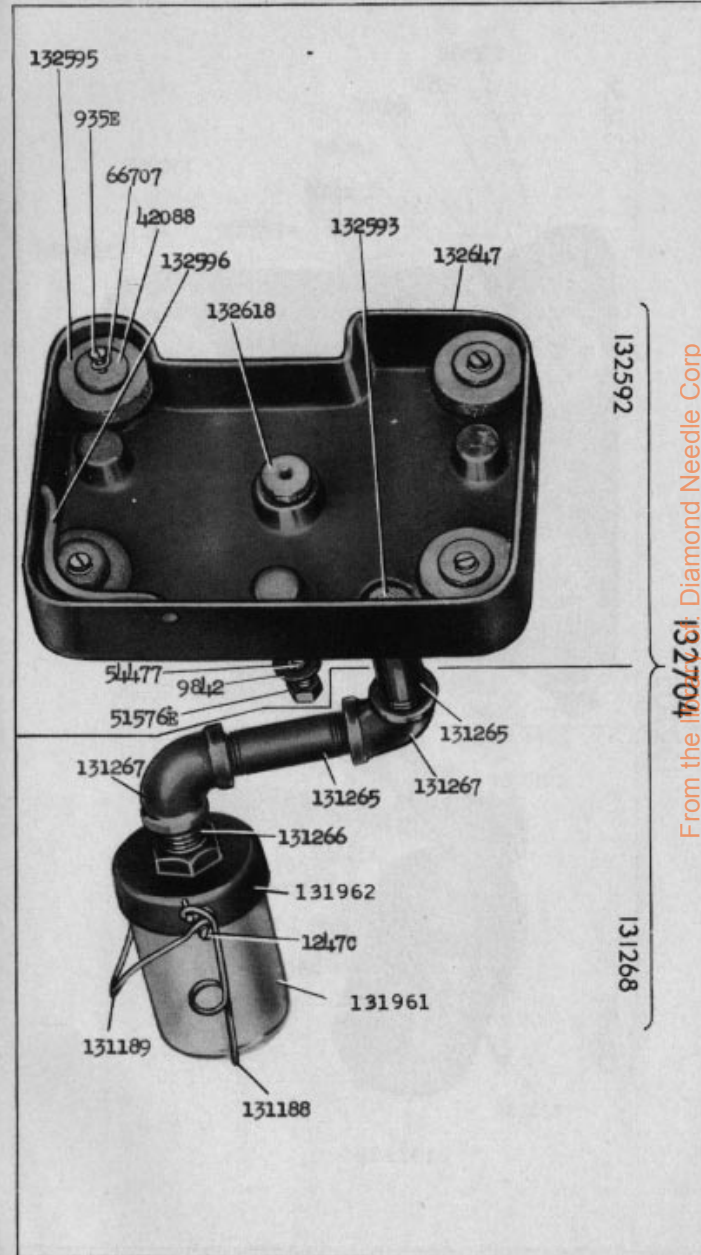

From the 132704 Diamond Needle Corp

23412-1/3

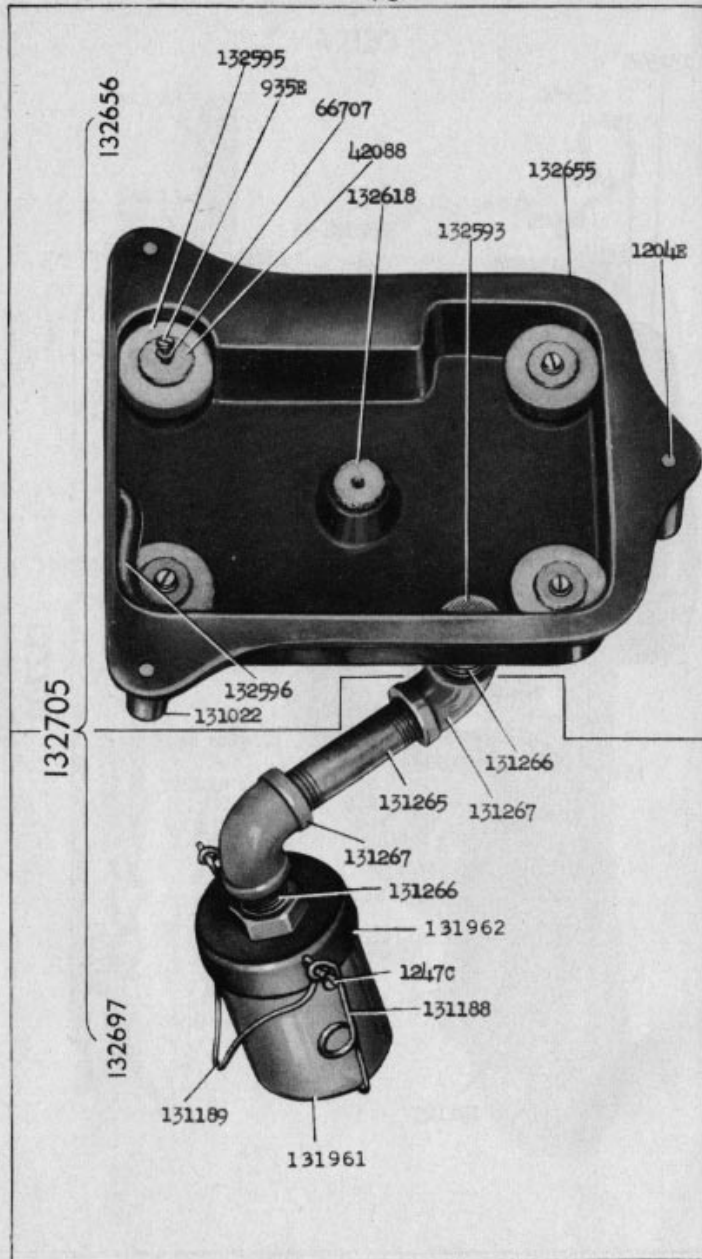

23413-1/6

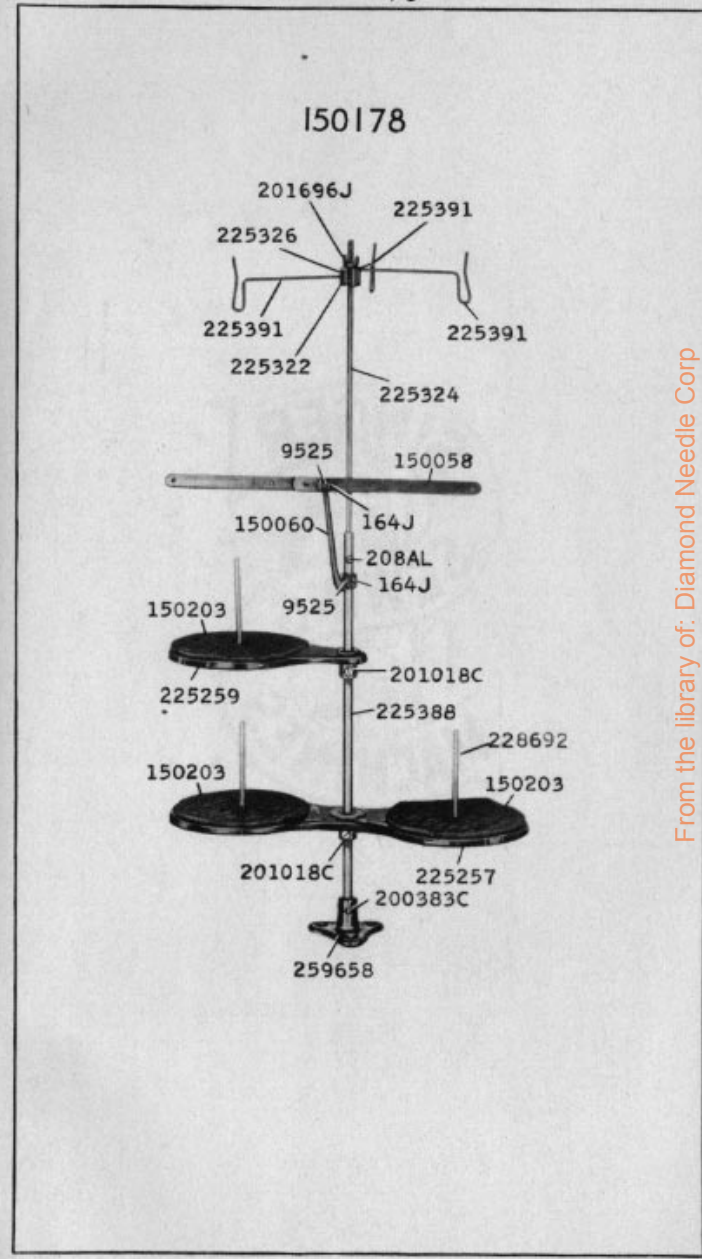

From the library of: Diamond Needle Corp